

A Journal for Ideas and  
Criticism in Architecture

Published for The Institute  
for Architecture and Urban Studies

By The MIT Press

Winter 1976:7

# OPPOSITIONS

In this issue:

**Editorial**

Anthony Vidler  
The Third Typology

**Oppositions**

Werner Seligmann  
Runcorn: Historical Precedent and  
the Rational Design Process

**History**

Martin Pawley  
"We shall not bulldoze Westminster  
Abbey": Archigram and the Retreat  
from Technology

Joseph Rykwert  
Classic and Neo-Classic

**Theory**

Bernard Tschumi  
Architecture and Transgression

**Documents**

*i 10*

Commentary, Bibliography,  
and Translations  
by Suzanne Frank

**Reviews, Letters and Forum**

A Journal for Ideas and  
Criticism in Architecture

Published for The Institute  
for Architecture and Urban Studies

By The MIT Press

Winter 1976:7

# OPPOSITIONS

In this issue:

**Editorial**

Anthony Vidler  
The Third Typology

**Oppositions**

Werner Seligmann  
Runcorn: Historical Precedent and  
the Rational Design Process

**History**

Martin Pawley  
"We shall not bulldoze Westminster  
Abbey": Archigram and the Retreat  
from Technology

Joseph Rykwert  
Classic and Neo-Classic

**Theory**

Bernard Tschumi  
Architecture and Transgression

**Documents**

*i 10*

Commentary, Bibliography,  
and Translations  
by Suzanne Frank

**Reviews, Letters and Forum**

**Editors**

Peter Eisenman  
Kenneth Frampton  
Mario Gandelsonas  
Anthony Vidler

**Managing Editor**

Julia Bloomfield

**Designer**

Massimo Vignelli

**Forum**

William Ellis

**Production**

Marlène Barsoum  
Jane Carolan  
Abigail Moseley  
A. Raleigh Perkins

**Editorial Consultant**

Joan Ockman

**Trustees of The Institute  
for Architecture and Urban Studies**

Armand Bartos, Chairman  
Charles de Carlo  
Arthur Drexler  
George A. Dudley  
Peter D. Eisenman  
John Entenza  
Frank O. Gehry  
Mrs. Frank Y. Larkin  
Richard Meier  
Peter Wolf

Subscriptions: one year (quarterly)  
Students (photocopy of I.D. required): \$20  
Individuals: \$28  
Institutions: \$35

Make checks payable to *Oppositions*  
and send to:  
The MIT Press Journals Department,  
28 Carleton Street,  
Cambridge, Mass. 02142.

All orders must be prepaid.  
Add \$1 for postage for each foreign  
subscription.

Application to mail at second class  
postage rates is pending at Boston,  
Massachusetts, and additional mailing  
offices.

OPPOSITIONS is a journal published for  
The Institute for Architecture  
and Urban Studies  
8 West 40 Street, New York, N.Y. 10018  
by The MIT Press  
28 Carleton Street, Cambridge, Mass. 02142.

© 1977 by The Institute for Architecture  
and Urban Studies and The MIT Press  
All rights reserved  
Printed in the United States of America

From the middle of the eighteenth century, two distinct typologies have informed the production of architecture. 1

The first, developed out of the rationalist philosophy of the Enlightenment, and initially formulated by the Abbé Laugier, proposed that a natural basis for design was to be found in the model of the primitive hut. The second, growing out of the need to confront the question of mass production at the end of the nineteenth century, and most clearly stated by Le Corbusier, proposed that the model of architectural design should be founded in the production process itself. Both typologies were firm in their belief that rational science, and later technological production, embodied the most progressive “forms” of the age, and that the mission of architecture was to conform to, and perhaps even master these forms as the agent of progress.

With the current questioning of the premises of the Modern Movement, there has been a renewed interest in the forms and fabric of pre-industrial cities, which again raises the issue of typology in architecture. From Aldo Rossi’s transformations of the formal structure and typical institutions of the eighteenth-century city, to the sketches of the brothers Krier that recall the primitive types of the Enlightenment *philosophes*, rapidly multiplying examples suggest the emergence of a new, third typology.

We might characterize the fundamental attribute of this third typology as an espousal, not of an abstract nature, nor of a technological utopia, but rather of the traditional city as the locus of its concern. The city, that is, provides the material for classification, and the forms of its artifacts provide the basis for re-composition. This third typology, like the first two, is clearly based on reason and classification as its guiding principles and thus differs markedly from those latter-day romanticisms of “townscape” and “strip-city” that have been proposed as replacements for Modern Movement urbanism since the fifties.

Nevertheless, a closer scrutiny reveals that the idea of type held by the eighteenth-century rationalists was of a very different order from that of the early modernists and that the third typology now emerging is radically different from both.

The celebrated “primitive hut” of Laugier, paradigm of the first typology, was founded on a belief in the rational order of nature; the origin of each architectural element was natural; the chain that linked the column to the hut to the city was parallel to the chain that linked

the natural world; and the primary geometries favored for the combination of type-elements were seen as expressive of the underlying form of nature beneath its surface appearance.

2 While the early Modern Movement also made an appeal to nature, it did so more as an analogy than as an ontological premise. It referred especially to the newly developing nature of the machine. This second typology of architecture was now equivalent to the typology of mass production objects (subject themselves to a quasi-Darwinian law of the selection of the fittest). The link established between the column, the house-type and the city was seen as analogous to the pyramid of production from the smallest tool to the most complex machine, and the primary geometrical forms of the new architecture were seen as the most appropriate for machine tooling.

In these two typologies, architecture, made by man, was being compared and legitimized by another “nature” outside itself. In the third typology, as exemplified in the work of the new Rationalists, however, there is no such attempt at validation. The columns, houses, and urban spaces, while linked in an unbreakable chain of continuity, refer only to their own nature as architectural elements, and their geometries are neither scientific nor technical but essentially architectural. It is clear that the nature referred to in these recent designs is no more nor less than the nature of the city itself, emptied of specific social content from any particular time and allowed to speak simply of its own *formal* condition.

This concept of the city as the site of a new typology is evidently born of a desire to stress the continuity of form and history against the fragmentation produced by the elemental, institutional, and mechanistic typologies of the recent past. The city is considered as a whole, its past and present revealed in its physical structure. It is in itself and of itself a new typology. This typology is not built up out of separate elements, nor assembled out of objects classified according to use, social ideology, or technical characteristics: it stands complete and ready to be de-composed into fragments. These fragments do not re-invent institutional type-forms nor repeat past typological forms: they are selected and reassembled according to criteria derived from three levels of meaning—the first, inherited from meanings ascribed by the past existence of the forms; the second, derived from choice of the specific fragment and its boundaries, which often cross between previous types; the third, proposed by a re-composition of these fragments in a new context.

Such an “ontology of the city” is indeed radical. It denies all the social utopian and progressively positivist definitions of architecture for the last two hundred years. No longer is architecture a realm that has to relate to a hypothesized “society” in order to be conceived and understood; no longer does “architecture write history” in the sense of particularizing a specific social condition in a specific time or place. The need to speak of function, of social mores—of anything, that is, beyond the nature of architectural form itself—is removed. At this point, as Victor Hugo realized so presciently in the 1830s, communication through the printed word, and lately through the mass media has released architecture from the role of “social book” into its specialized domain.

This does not of course mean that architecture in this sense no longer performs any function, no longer satisfies any need beyond the whim of an “art for art’s sake” designer, but simply that the principal conditions for the invention of object and environments do not necessarily have to include a unitary statement of fit between form and use. Here it is that the adoption of the *city* as the site for the identification of the architectural typology becomes crucial. In the accumulated experience of the city, its public spaces and institutional forms, a typology can be understood that defies a one-to-one reading of function, but which, at the same time, ensures a relation at another level to a continuing tradition of city life. The distinguishing characteristic of the new ontology beyond the specifically formal aspect is that the city, as opposed to the single column, the hut-house, or the useful machine, is and always has been political in its essence. The fragmentation and re-composition of its spatial and institutional forms thereby can never be separated from the political implications.

3

When a series of typical forms are selected from the past of a city, they do not come, however dismembered, deprived of their original political and social meaning. The original sense of the form, the layers of accrued implication deposited by time and human experience cannot be lightly brushed away; and certainly it is not the intention of the Rationalists to disinfect their types in this way. Rather, the carried meanings of these types may be used to provide a key to their newly invested meanings. The technique, or rather the fundamental compositional method suggested by the Rationalists is the transformation of selected types—partial or whole—into entirely new entities that draw their communicative power and potential critical force from the understanding of this transformation. The City Hall project for Trieste by Aldo Rossi, for example, has been rightly understood to refer, among other evocations in its complex form, to the image of a late eighteenth-century prison. In the period of the first formalization of this type, as Piranesi demonstrated, it was possible to see in *prison* a powerfully comprehensive image of the dilemma of society itself, poised between a disintegrating religious faith and a materialist reason. Now, Rossi, in ascribing to the city-hall (itself a recognizable type in the nineteenth century) the affect of prison, attains a new level of signification, which evidently is a reference to the ambiguous condition of civic government. In the formulation, the two types are not merged: indeed, city hall has been replaced by open arcade standing in contradiction on prison. The dialectic is clear as a fable: the society that understands the reference to prison will still have need of the reminder, while at the very point that the image finally loses all meaning, the society will either have become entirely prison, or, perhaps, its opposite. The metaphoric opposition deployed in this example can be traced in many of Rossi’s schemes and in the work of the Rationalists as a whole, not only in institutional form but also in the spaces of the city.

This new typology is explicitly critical of the Modern Movement; it utilizes the clarity of the eighteenth-century city to rebuke the fragmentation, de-centralization, and formal disintegration introduced into contemporary urban life by the zoning techniques and technological advances of the twenties. While the Modern Movement found its hell in the closed, cramped, and insalubrious quarters of the old industrial

4 cities, and its Eden in the uninterrupted sea of sunlit space filled with greenery—a city become a garden—the new typology as a critique of modern urbanism raises the continuous fabric, the clear distinction between public and private marked by the walls of street and square, to the level of principle. Its nightmare is the isolated building set in an undifferentiated park. The heroes of this new typology are therefore to be found not among the nostalgic, anti-city utopians of the nineteenth century nor among the critics of industrial and technical progress of the twentieth, but rather among those who, as the professional servants of urban life, direct their design skills to solving the questions of avenue, arcade, street and square, park and house, institution and equipment in a continuous typology of elements that together coheres with past fabric and present intervention to make one comprehensible experience of the city.

For this typology, there is no clear set of rules for the transformations and their objects, nor any polemically defined set of historical precedents. Nor should there be; the continued vitality of this architectural practice rests in its essential engagement with the precise demands of the present and not in any holistic mythicization of the past. It refuses any “nostalgia” in its evocations of history, except to give its restorations sharper focus; it refuses all unitary descriptions of the social meaning of form, recognizing the specious quality of any single ascription of social order to an architectural order; it finally refuses all eclecticism, resolutely filtering its “quotations” through the lens of a modernist aesthetic. In this sense, it is an entirely modern movement, and one that places its faith in the essentially public nature of all architecture, as against the increasingly private visions of romantic individualists in the last decade. In it, the city and typology are reasserted as the only possible bases for the restoration of a critical role to an architecture otherwise assassinated by the apparently endless cycle of production and consumption.

**Runcorn:  
Historical Precedent and the Rational Design Process**

Werner Seligmann

Werner Seligmann was born in Osnabrück, Germany, and received his architectural education at Cornell University and the Technische Hochschule, Braunschweig, Germany. He has taught at the University of Texas; the Swiss Federal Institute of Technology, Zurich; Cornell University; and Harvard University. He is presently Dean of the School of Architecture at Syracuse University. He is principal in the firm of Werner Seligmann and Associates. His built works include U.D.C. housing in Ithaca, New York; a hospital administration building in Willard, New York; and a science building in Cortland, New York.

## Introduction

Anthony Vidler

6 Since the first industrial revolution, a humanistically conceived architecture has been forced to assimilate the emerging realities of machine production and mass society; the former by analogy or technical development, the latter by the attempted solution of the housing question. James Stirling's housing at Runcorn, designed in the mid-sixties by one of Europe's most idiosyncratic architects, yet apparently adopting a "systems" approach toward its planning and construction, embodies all the tensions and contradictions that have marked architecture as it has confronted this twin threat (or potential) of mass production and mass housing.

Initially, the image of the economically functioning machine was adduced by architects to explain how architecture might better serve a society on which it was dependent, or even operate on that society for its reform or control in the manner of a technical instrument. Thus Jeremy Bentham referred to his celebrated Panopticon as an "engine" for the modification of human behavior. A second effect of industrialization was to supply mass-produced standardized parts for the assembly of utilitarian building; the glass houses, arcades, railway stations, and exhibition halls, of which the Crystal Palace was the most paradigmatic example. Such constructions were hardly admitted into "architecture" at first, by virtue of their unabashedly temporary and serial qualities. The machine was thus absorbed by architecture in two ways: architecture could function *like* a machine and gain a new identity for itself aesthetically and programmatically through the *analogy*, or it could actually be *produced* by machine and derive its new forms from the world of industrial process itself.

In the nineteenth century, both of these modes of relating to the machine were retained within a traditional conception of architecture by being subordinated to the idea of *type*. The type "prison," or the type "exhibition hall" although developed to serve new social needs were each understood to partake of the architectural tradition by their formal reference to traditional typologies. The central plan of the Panopticon turned the vision of Renaissance order in upon itself; the "cathedral" plan of the Crystal Palace endowed the profane with sacred authority. Some types, like hospitals, were built up of type-elements (the ward-blocks) and

relied on the grid of the classical town to give them institutional form.

With the introduction of the need for mass housing, however, this interrelation of machine analogy and type-form began to break down. The initial assimilation to the type "palace" (the Phalanstery of Fourier, the Familistery of Godin) was rapidly overtaken by the expanding demand for quickly constructed cheap dwellings. The "architectural" boundaries of the problem were overrun and housing became an affair of economics to be controlled, if at all, by the techniques of zoning.

The Modern Movement attempted to overcome this problem on behalf of architecture by formulating new typologies for housing and their technical systems of construction. The most sophisticated version of this attempt was produced by Le Corbusier. He proposed an acceptance of the machine at both the level of analogy and of production: the iconography of the Villa at Garches referred to the *idea* of "a machine for living in" and the specifications of the Maison Citrohan transferred the mass-production techniques of Ford to those of houses.

Despite his ideological and iconographic appeal to the twin heroes of modern technocracy, F. W. Taylor and Henry Ford, Le Corbusier retained a profoundly traditional vision of architecture. Each house, each villa, was endowed with a specific and humanistically idealized geometry; its masses, surfaces, proportions, and spatial organization were all subjected to the canons of a purist classicism. The mass-produced house, with all the volumetric qualities of the artist's studio, was, however, many times replicated, a palace in its own right. There existed an unbreakable cultural chain between the types of palace, villa, and house.

Similarly, when the single units of dwelling were aggregated, a new scale of type-form was proposed: the Immeubles-villas and the Unité d'Habitation each subsume their mass-produced elements in a complete whole, a new type of architectural unity.

In this classical understanding of the role of type-form in

architecture, seen as in some way analogous to the typical forms of machines (car, aeroplane, ship; house, temple, palace), Le Corbusier was standing against the tendency, evinced by the German functionalists from Walter Gropius to Hannes Meyer, to completely absorb a traditional architecture in the standardized repetitions of mass production. For Gropius, in spite of his professed craft affiliations, in the end thought of housing as the rational aggregation of units according to scientific criteria of construction, orientation, and amenity. The extruded section of the Siedlung row house succeeds in eliminating any traditional idea of formal or harmonic unity. While Le Corbusier eradicated the dichotomy Architecture:Building by raising all tasks to the "status" of an artistically governed architecture, the theoreticians of the *neue Sachlichkeit* tended to reduce all to a single level of building in the name of rational function.

Yet the common emphasis on type was an evident attempt once more to make out of housing an institutional form, susceptible to the ordering devices of the architect. Herein lay the critical failure of the Modern Movement in the domain of housing; for when these *institutions*, however carefully devised and technically realized, were replicated *en masse*, their hermetic and self-contained forms proved antipathetical to any vision of urban, and ultimately social, continuity and connectivity. When allied to the pathology of the nineteenth-century slum, which called for sun, light, air, and greenery, these types destroyed the urban street and denied the urban culture of their intended inhabitants. The critique of this Modern Movement tradition has occupied architects and planners since the fifties, from Team X to the new Rationalists; but the contradictions still largely remain, between a tradition of formal design that stresses unity, an understanding of the city that embraces both its insalubrity and its culture, a mass society expanding into ever-multiplied consumer markets, and a mass production potential that has yet to be completely realized within the building industry.

In the work of Stirling, these contradictions and potentialities are not only repeated, but, by virtue of the mastery of form and technique he displays, transformed in critical ways and raised to the new level of explicitness. In Leices-

ter, the building *like* a machine (the vertical tower) stands alongside the building *produced* by machine (the laboratory block); in the Cambridge library, the reading room is conceived like a Panopticon, the vertical offices as the mass-produced service spaces; in the Siemen's competition entry, the building has, as it were, almost entirely become machine. And in all three designs, we sense a drive toward the development of unique type-forms that might be replicated. In Runcorn, these tendencies come together, but in a way that, as the following article demonstrates, marks a turning point in Stirling's *oeuvre* as he tries to assimilate not only the tradition of the Modern Movement in housing, but also its critique from the double point of view of the revised functionalism and revived historical sensibility of the sixties and seventies.

1 Runcorn New Town housing,  
England. James Stirling, architect,  
1967. View down footway, second  
floor level.

8

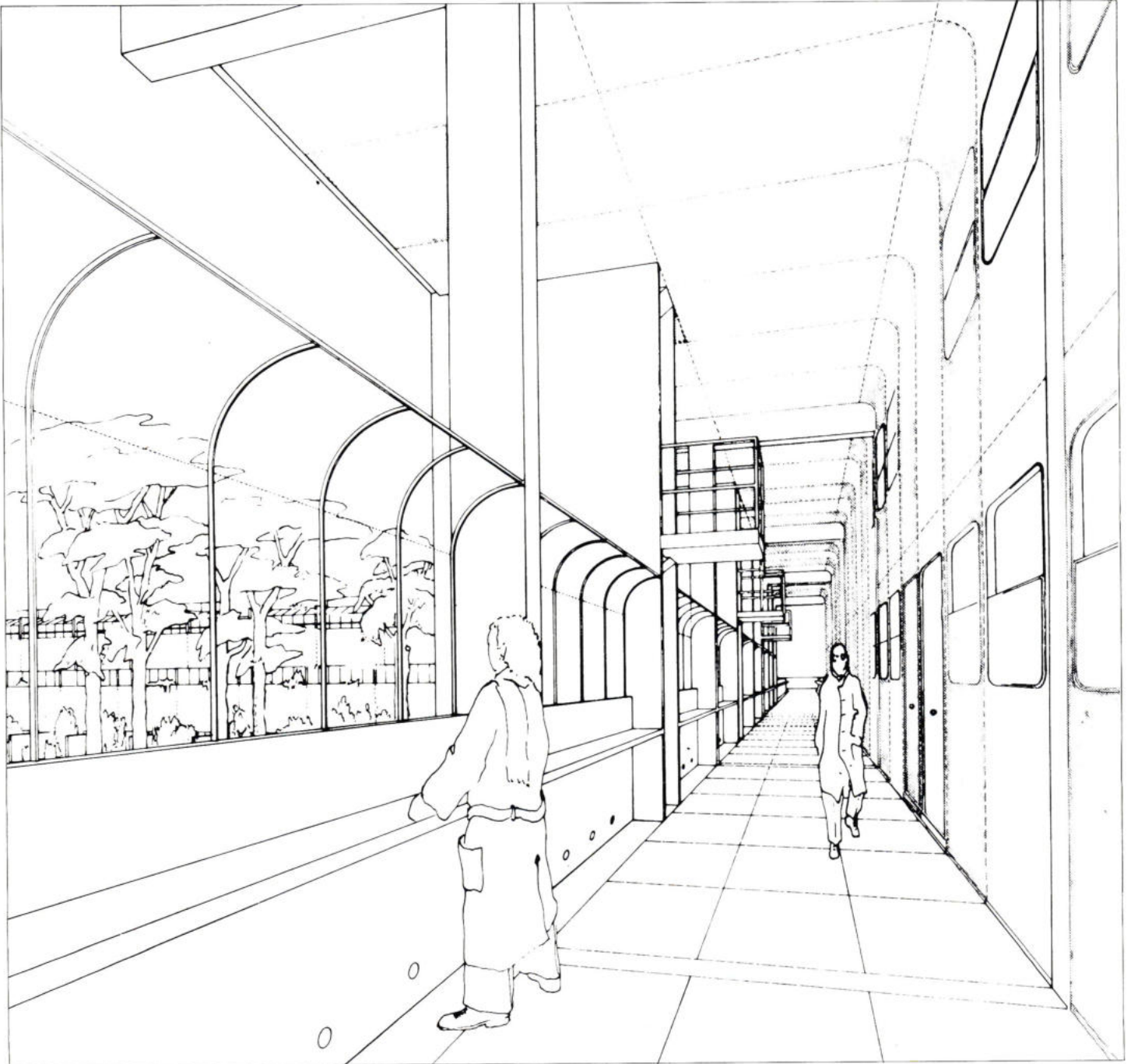

1

**Runcorn:  
Historical Precedent and the Rational Design Process**

Werner Seligmann

The significant contributions to housing in recent years can be counted on the fingers of both hands. Progress in the design of housing is slow and incremental, and almost without exception it arises as a result of carefully considered variations on the themes of established models. For example, we can see Siedlung Halen as a horizontal version of the Unité d'Habitation at Marseilles by Le Corbusier, or the project by Candilis, Josic, and Woods for Toulouse-le-Mirail as a variant of Le Corbusier's *redent* scheme. In the realm of public housing, programmatic requirements tend to evolve over a long period of time and do not change radically. Thus housing standards vary only slightly from one agency to another or even from country to country. 9

In this light it is useful to compare Runcorn to an earlier prototype, say, for example, to the competition project for Haselhorst near Berlin, designed by Walter Gropius in 1929. Although such a comparison may seem to be somewhat gratuitous, it may be employed as a means of assessing the significance of Runcorn in the history of modern housing. Despite their overt differences, the model photographs of the two schemes (figs. 2, 3) reveal on closer analysis some surprising similarities in design attitude and assumptions. The two solutions not only present arguments about the rational process of design but also display a tendency toward the reduction or elimination of any empirical detail. Both projects are highly articulated and composed of repetitive, similar elements.

The Gropius plan is organized in parallel rows which are crossed by a series of perpendicular roads and a central green zone. A grid is thereby formed at ground level, stressed in one direction by the individual housing blocks of varying lengths all with the same orientation. The Stirling scheme is also essentially a grid but composed of housing blocks of identical lengths set along all four sides of the grid squares. Furthermore, both schemes have a distinct head. The Gropius scheme culminates in a set of twelve-story-high apartment slabs perpendicular to the basic grain of the fabric. Runcorn has as its head the town center which, like the high-rise units in the Gropius scheme, is clearly articulated from the remainder of the project. In the Gropius plan the grid exists merely in plan, for the parallel rows of

2 Runcorn New Town housing, England. James Stirling, architect, 1967. Model of housing and urban motorways.

3 Haselhorst housing, Berlin. Walter Gropius, architect, 1929. Model.

4 Development of a rectangular building site with parallel rows of

tenement blocks of different heights. Walter Gropius, architect, 1930.

5 Sketch by Le Corbusier showing "sun, space, and greenery," 1939.

6 Runcorn New Town housing, England. James Stirling, architect, 1967. Diagrammatic section.

10

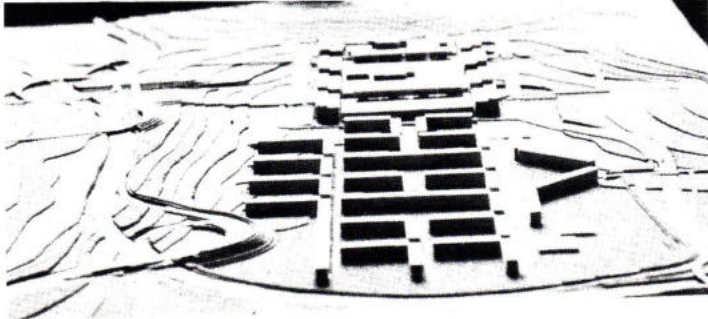

2

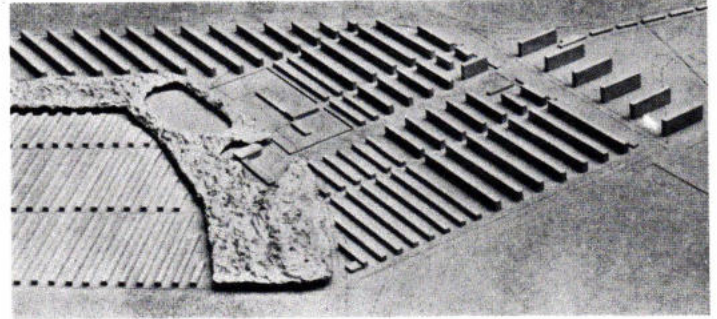

3

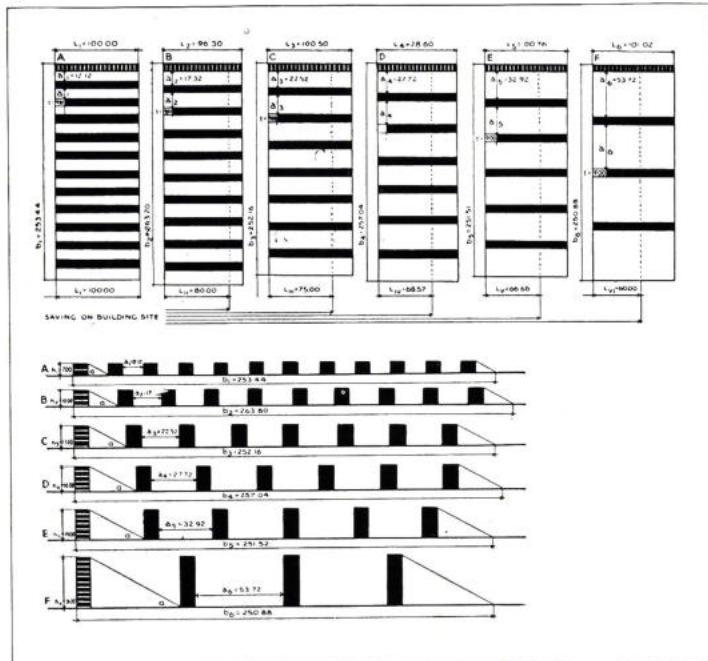

4

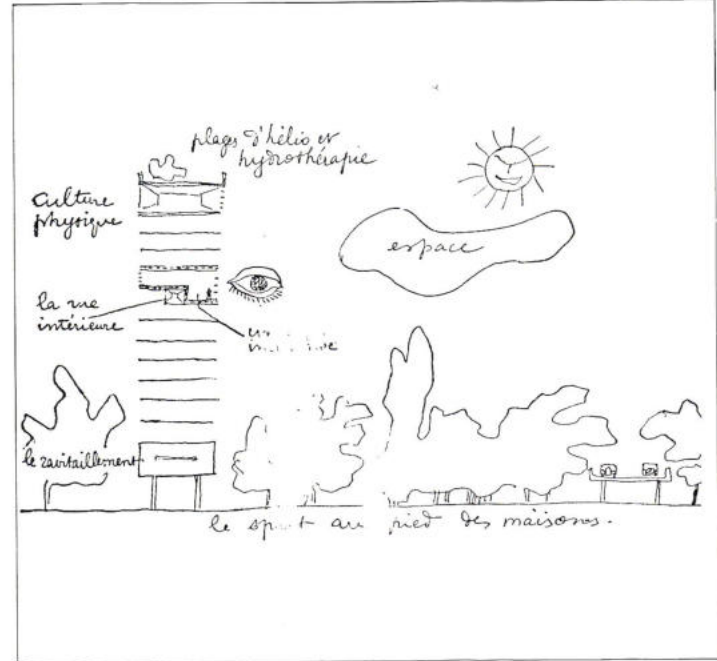

5

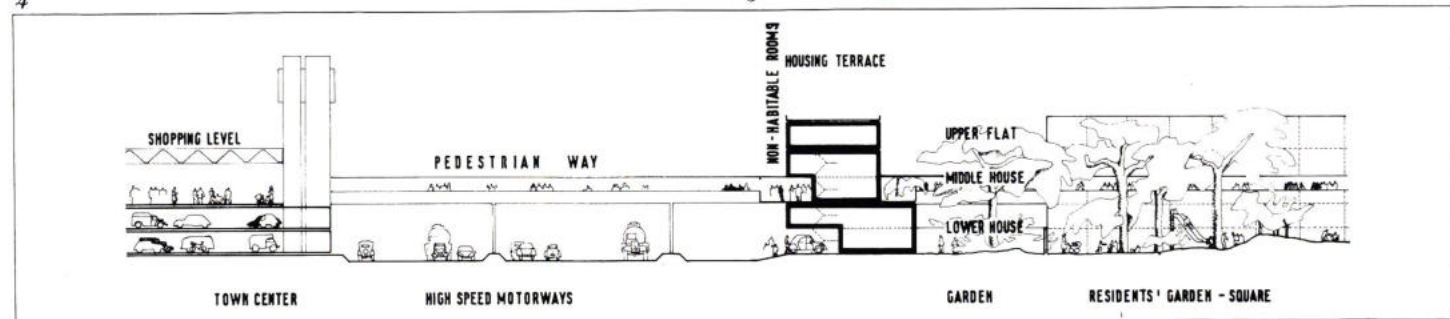

6

housing remain as the dominant form, whereas in Stirling's layout the buildings themselves make the grid.

This similarity in plan is also evident when we look at the respective sections (fig. 4). In his book, Stirling publishes a diagrammatic section of his housing units (fig. 6) which remind one of similar sketches published by Le Corbusier during the 1920s (fig. 5). Stirling's drawing is clearly not just a design sketch but obviously intended to be a polemical statement. It is, in fact, a declaration of the extra-programmatic issues governing the design decisions. According to the sketch, the principal spaces of all units within the project would enjoy proper sun, exposure, and relate to the private green park space of the squares. All units would have through-ventilation and would basically be organized in terms of a noisy public side and a quiet private side. Logically, the largest and also the lowest unit would enjoy direct access to the ground and control its own piece of land. The circulation to the units would be clearly segregated from dangerous automobile traffic and conveniently connected by bridges to the town center which provides such amenities as shopping, schools, and places for leisure activities. These criteria are, evidently, the often-repeated premises that have governed the designs of modern housing for the last fifty years.

Housing for the Modern Movement was synonymous with the new society. The new world was to be egalitarian and objective. To make this new world possible it was to avail itself of the latest scientific methods and techniques and management models used by industry. The construction site became the factory and the construction process was modelled after the assembly line process of the automobile industry. Following this ideology, J. J. P. Oud called his housing type at Kiefhoek in Rotterdam "the dwelling Ford," while Le Corbusier named his typical housing unit of the early twenties "Citrohan" in obvious reference to the Citroën automobile. This tendency was equally evident in the late fifties and early sixties in the work of Team X, and in particular in that of Candilis, Josic, and Woods who, in taking the premise of mass production to its logical extreme and in relying on the continuous grid as a basic ordering device, effectively removed housing from the domain of

architecture. The Free University of Berlin (fig. 8), for example, established a circulation network which allowed for a variable infill and continuous extension in all directions. The idea of the single architectural building—still dominant in, say, Caius College, Cambridge, by Leslie Martin and Colin St. John Wilson (fig. 9)—was here completely absorbed by the grid. Similarly, Le Corbusier's designs for the Venice Hospital utilize a network concept of form diametrically opposed to his earlier geometrically pristine enclosures. This concept of "mat-building" became particularly prominent in the sixties, responding to the apparent need for continuity, growth, and change as posed by modern consumer society. Such projects have no fixed perimeter: they rely on the circulation network and its intersection points for their places of reference.

In the design of Runcorn we may see the influence of this concern demonstrated by Stirling's studies for alternative grids on the site. The extraordinary number of these studies would indicate a working method that in its stress on *process* parallels the use of grids as design solutions.

Stirling's design process proceeds systematically. His studies for the project have the appearance of an organizational matrix; the design investigation apparently proceeding from step-to-step in infinitely small variables. Accompanying the investigation are other studies, of an even more systematic nature, dealing with cross-sectional alternatives and plan widths in terms of unit distribution and access locations (figs. 10–12). Each combination is subjected to a series of permutations statistically tabulated, an optimizing method that has the appearance of simulating computer processes. The method, reminiscent of the work of Alexander Klein (fig. 7), also implies total neutrality on the part of the designer: by logical deduction the optimum solution will be automatically developed; the designer has merely to be the midwife to the process.

Such a hypothesis is obviously an exaggeration and certainly would never be subscribed to by Stirling. For Stirling, methodical evaluation can serve only as basic information and must thereafter be subjected to an inherently intuitive process that addresses itself to lifestyle and place.

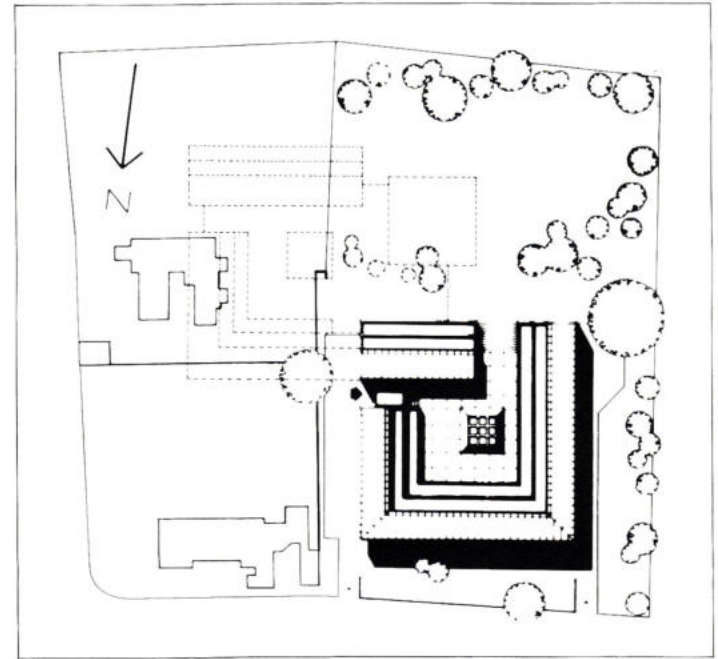
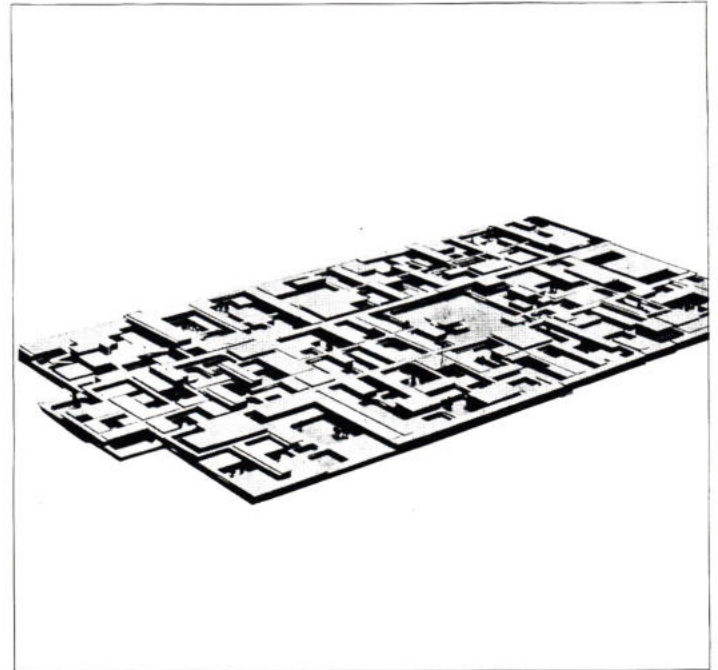
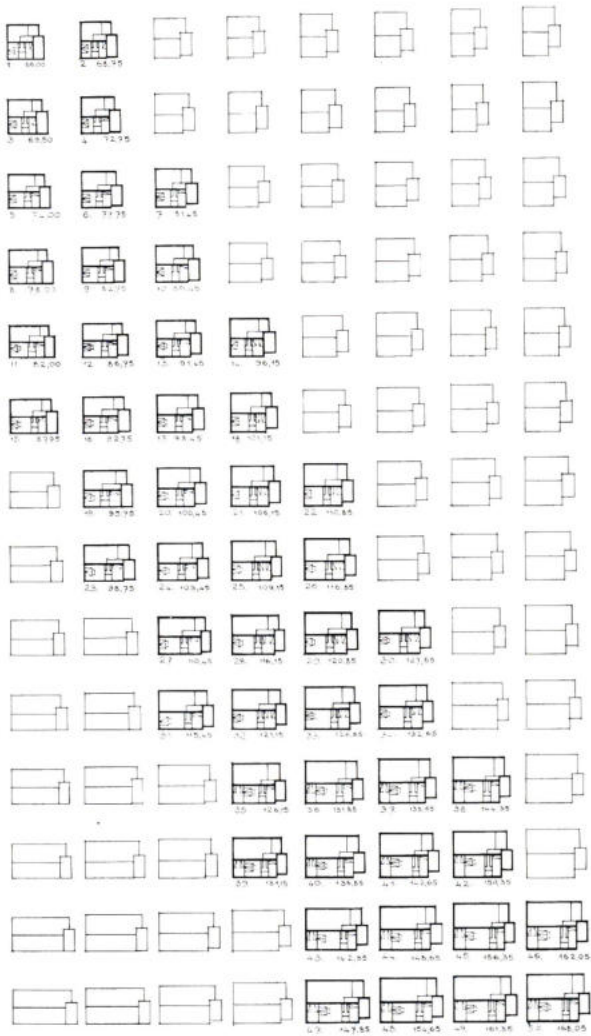

7 Variations in housing types.  
Alexander Klein, 1928.

8 Free University, Berlin. Shadrach  
Woods, architect, 1964. Model, view  
from the south.

9 Caius College, Cambridge. Sir  
Leslie Martin and Colin St. John  
Wilson, architects, 1962. Although

realized as a free-standing structure,  
the basic type-form was capable of  
being assembled into a larger whole.

10 Runcorn New Town housing,  
England. James Stirling, architect,  
1967. Alternative layouts presented  
as a schematic urban typology  
reminiscent of the approach of Klein.

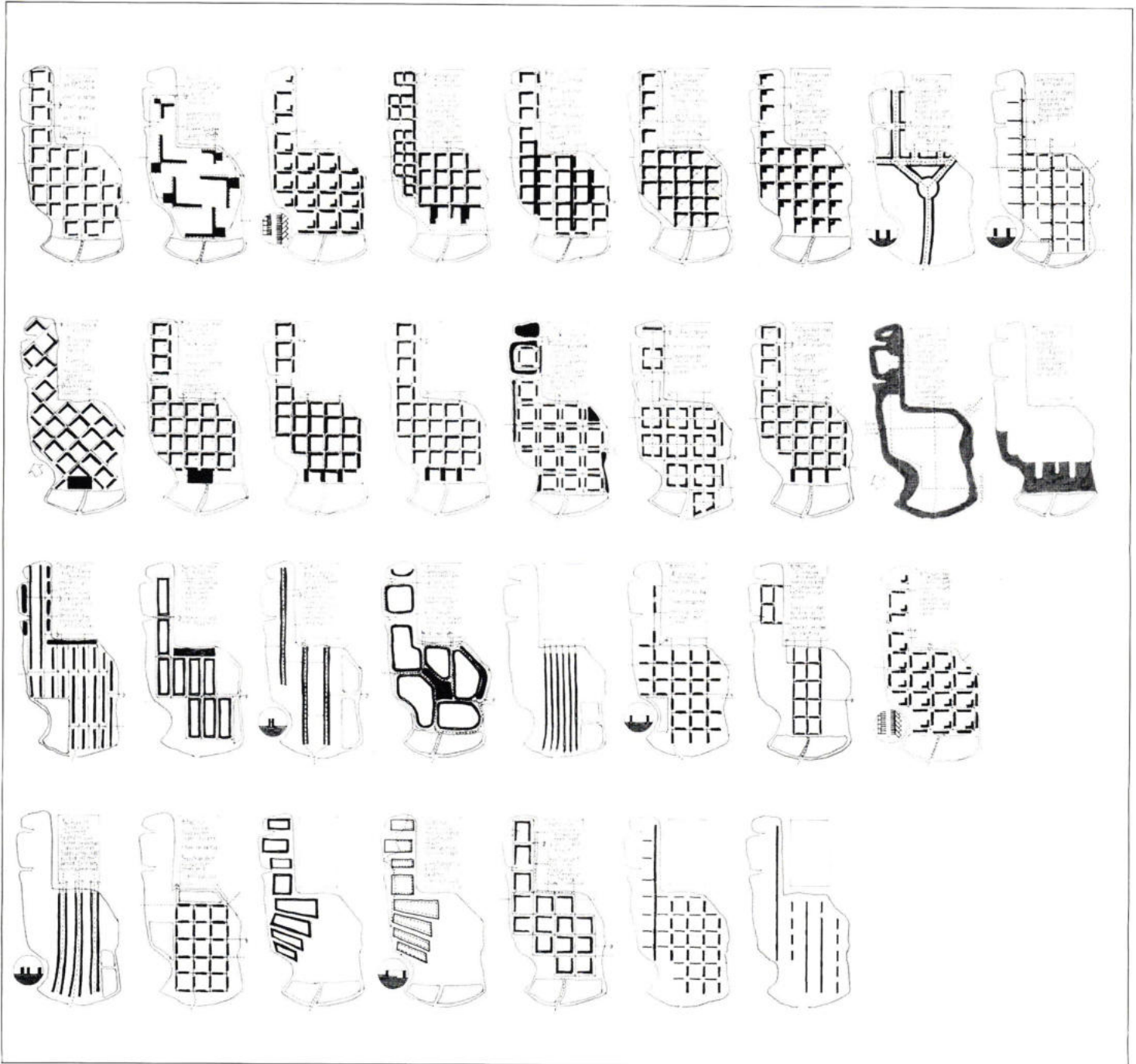

11 Runcorn New Town housing, England. James Stirling, architect, 1967. Study of plan widths of unit distribution.

12 Study of sections of unit distribution.

13-16 Sketches by James Stirling showing traditional urban prototypes

related to Runcorn (13 The Circus, Bath, c.1754; 14 Bedford Square, London, c.1775; 15 Charlotte Square, Edinburgh, c.1770; and 16 Queen's Square, Bath, c.1730).

17 Bloomsbury, London, c.1770.

18 The Circus, Bath, c.1754, and The Royal Crescent, Bath, c.1767.

14

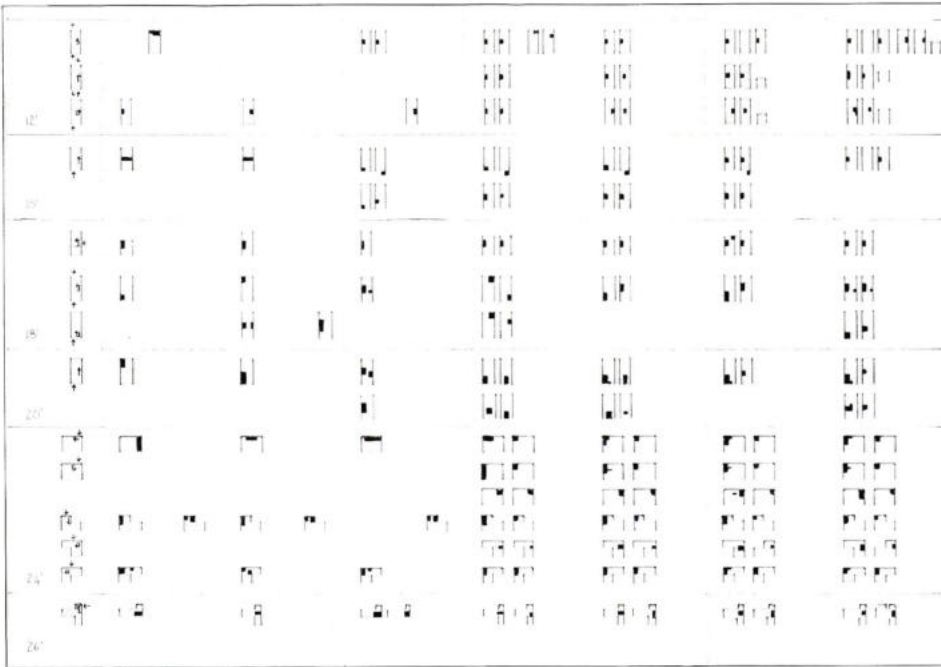

11

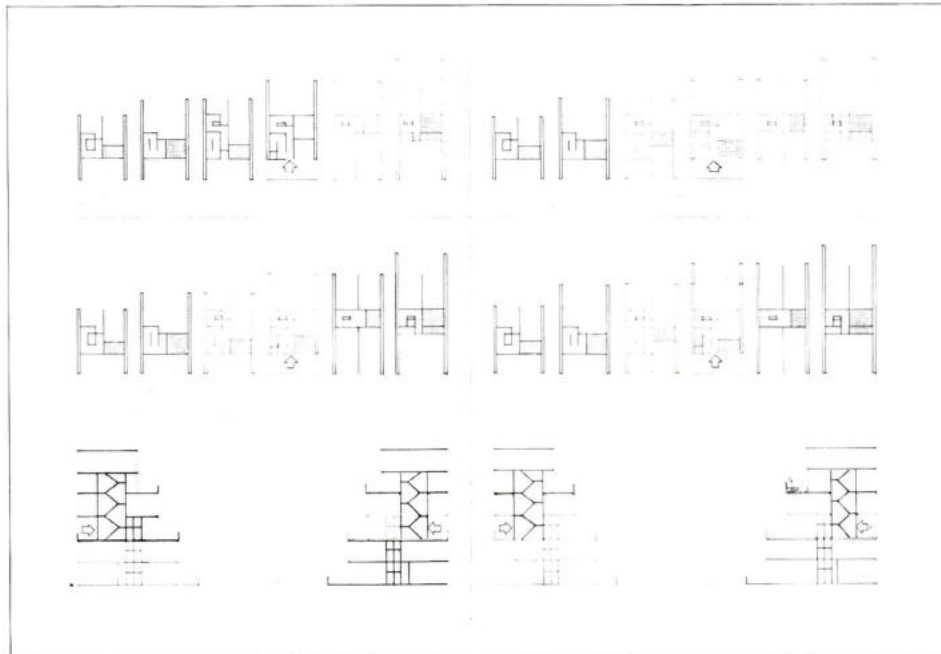

12

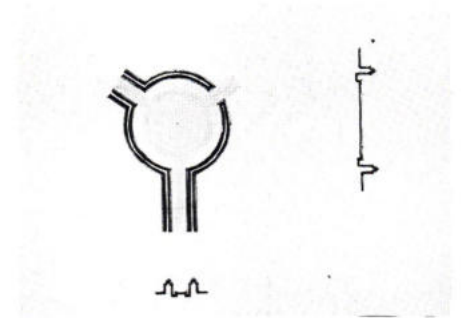

13

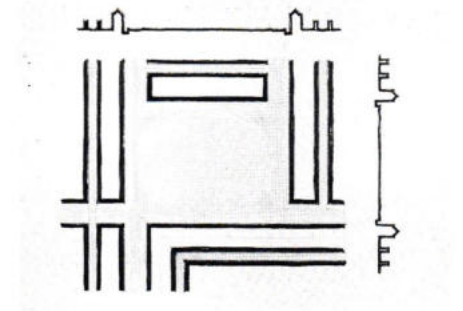

14

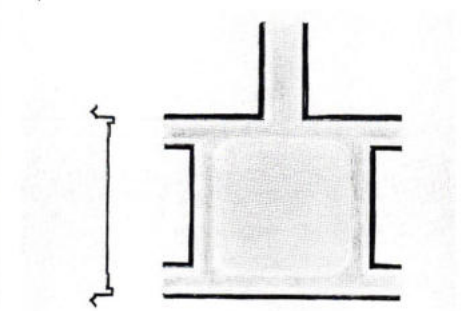

15

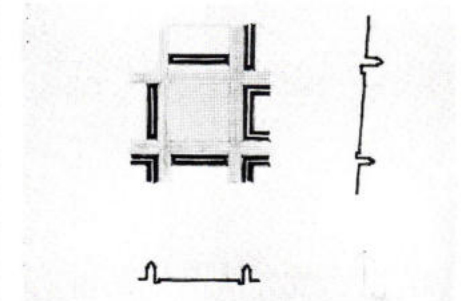

16

19-21 Runcorn New Town housing, England. James Stirling; architect, 1967. Studies for site layout. Variations involving the manipulation of traditional urban prototypes.

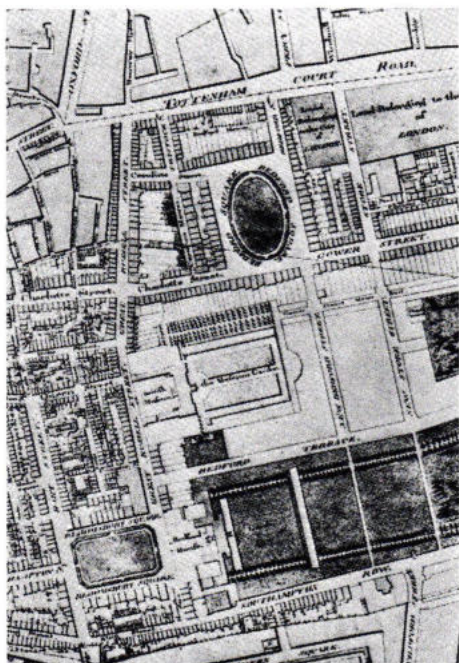

17

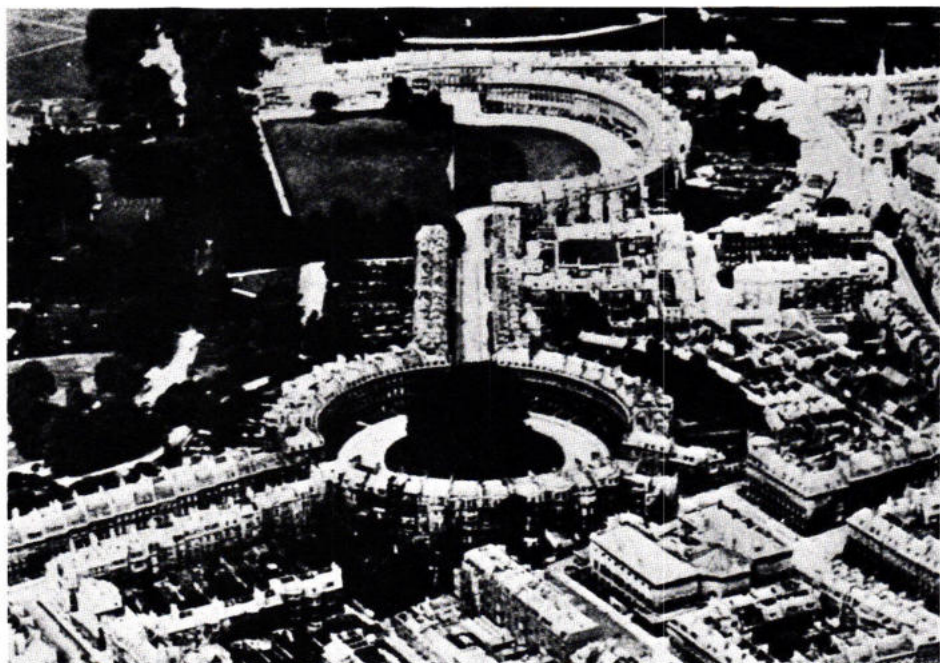

18

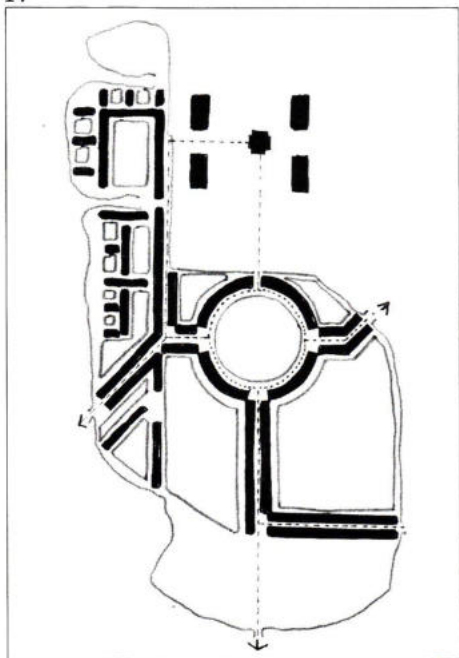

19

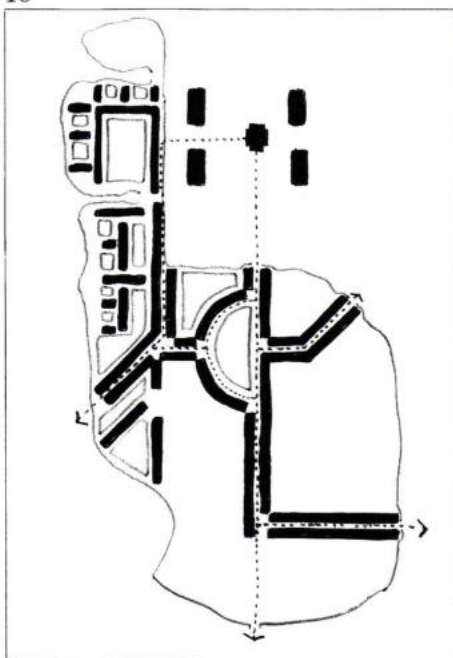

20

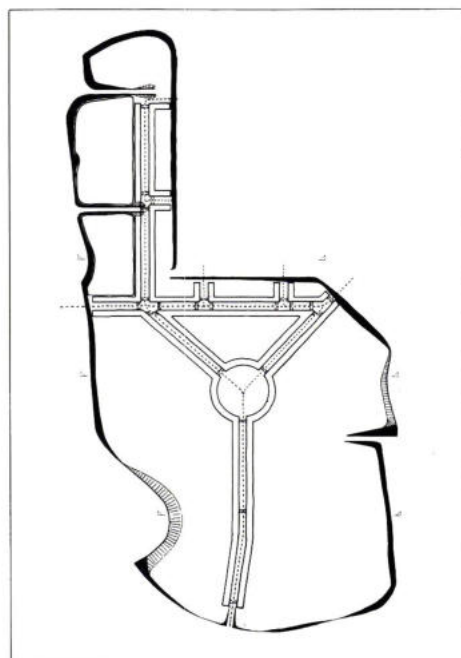

21

16 The fact that Stirling accompanies the plans of Runcorn with spatial diagrams of the eighteenth-century squares and crescents of Bath and London would indicate that these models were certainly more important than any preoccupation with the grid (figs. 13–17). Indeed Stirling seems to have begun by trying to organize the site layout according to such precedents (figs. 19–21). However, for all their great image quality and their hierarchical nature, spaces like the circus and crescent at Bath (fig. 18) demand considerable flexibility of accommodation from the built fabric. The figural nature of such planning with its strategy of urban infill behind the primary facades relies on the ability of form to resolve unique conditions, and is basically a-systematic. This is contrary to the logic of mass housing produced by systematized construction that tends either toward a built-in redundancy in the system or toward the maximum reduction of special conditions. Despite Runcorn's commitment to mass production, there is an evident attempt to recuperate the urban qualities of English neo-classical planning not only as an implied criticism of the sterility of Zeilenbau developments but also of the inherent fragmentation of the English New Town tradition.

A number of typological alternatives are demonstrated in Stirling's diagrammatic site studies. One of these is a modern variation of the conventional solid city block with public corridor streets and an interior private domain. While this produces a sharp differentiation between the life of the street and the activity within the block (fig. 23), it also results in a series of isolated housing units, even if, as in this case, they are connected by a pedestrian deck elevated above the vehicular traffic. A further consequence is a certain ambiguity with regard to 'fronts' and 'backs' and an undesirable orientation for some of the units as well as the generation of difficult conditions at the corners. A second type of pattern with single loaded blocks produces, on the assumption of through-units, a checkerboard effect of public and private spaces (fig. 24). On the assumption that major living spaces consistently face north, this scheme produces similar undesirable orientation conditions. A third type similar to the Gropius Haselhorst arrangement avoided such problems, however where the Gropius scheme was a-spatial and open, Stirling's square grid solution was spa-

tial and enclosed. Stirling's final solution (fig. 25) is a grid which may be seen as the insertion of perpendicular blocks into the Zeilenbau rows or, alternatively, and probably more correctly, as a series of stacked L-shapes or bent walls producing square spaces. While the private zone faces south and west and is lined by the major living spaces, the outside of the "L" faces north and east and comprises circulation and the minor programmatic spaces. The distance separating the "L's" provides the space required for automobile circulation: a planning device which introduces automobiles into two adjacent sides of every courtyard. Although this results in a set of undifferentiated squares, it nonetheless produces a sequence of distinct private green spaces which are directly connected to the housing units. The cross section of the walls facing the square is stepped in section—producing an amphitheater-like space toward the private green space that provides a sense of connection to the ground for the upper units (fig. 22). Stirling interrupts the pattern, to produce differentiated spaces within the system, by leaving out single housing blocks and introducing double square voids within the fabric.

The nature of the construction, however, the repetitive, parallel wallbearing system, which forms the cellular five story package, is not capable in itself of accommodating the corner conditions—a function which is made all the more problematic when the section is stepped (figs. 26–29). As a result of this, the grid squares are formed by isolated blocks of terraced row housing; a degree of individuation that produces an even greater similarity to the Gropius project. The resulting separation of each row of terrace units causes visual and spatial leaks at the corners and vitiates the sense of closure suggested by the diagram. This effect is further aggravated by the scale difference between the circulation perimeter of the "L" forms and the terrace sides. The articulation of the stair towers and the treatment of the upper floor as a continuous architrave makes this perimeter of the squares overscaled and monumental in comparison with the stepped terraces. The monumentality of this architrave is emphasized by use of round windows which only serves to stress the massiveness of the scale (fig. 31). Since the stairs carry only light, occasional, internal traffic they might have been discreetly tucked away, rather than being developed

22 Runcorn New Town housing, England. James Stirling, architect, 1967. View showing the double height void and stepped facades facing the green space.

23,24 Penultimate site layout studies showing various attempts to accommodate alternative urban elements.

25 Site layout, final scheme.

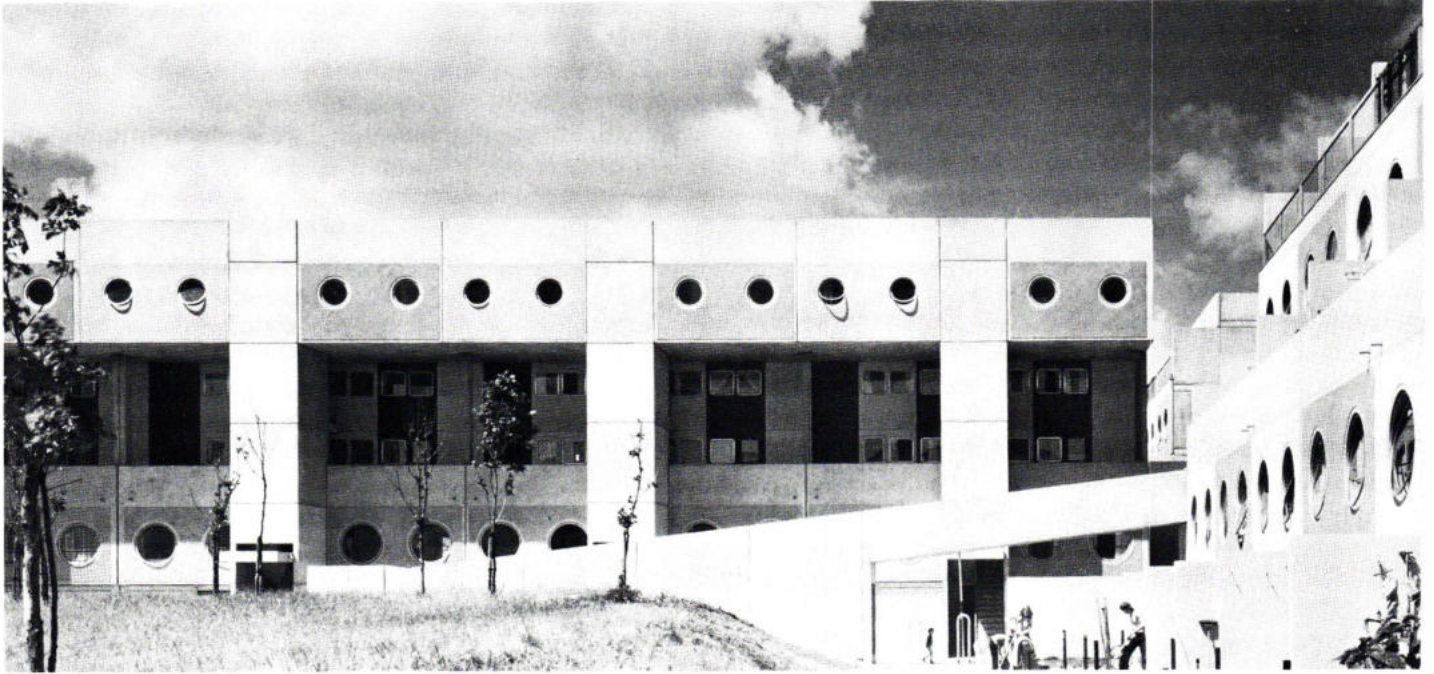

22

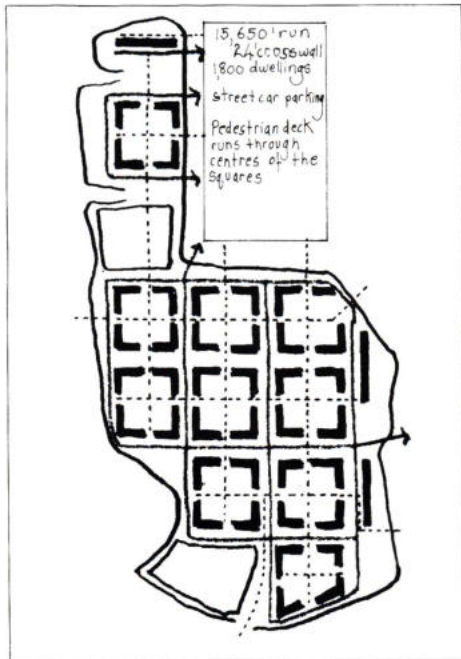

23

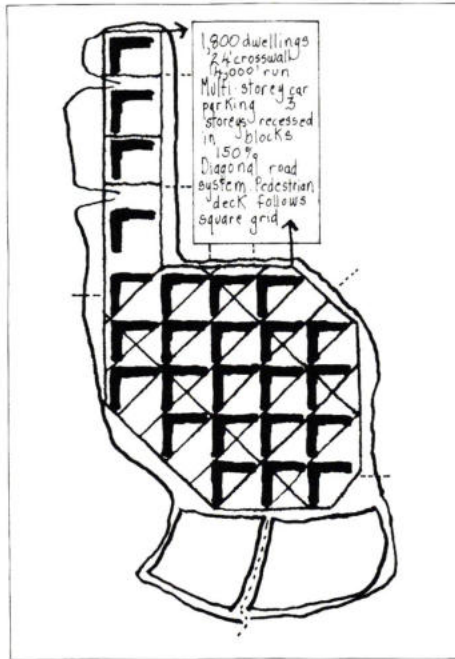

24

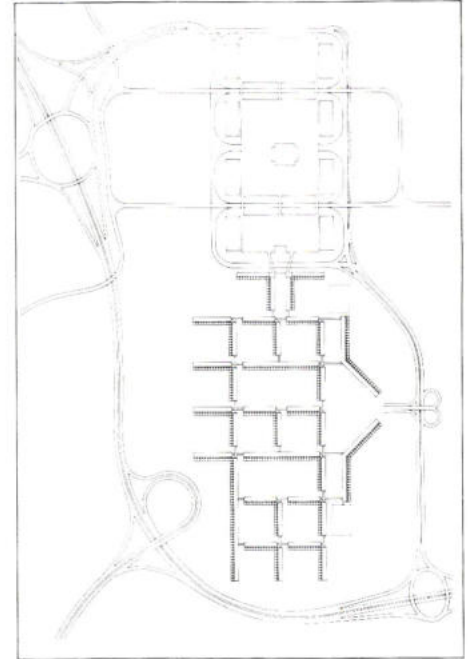

25

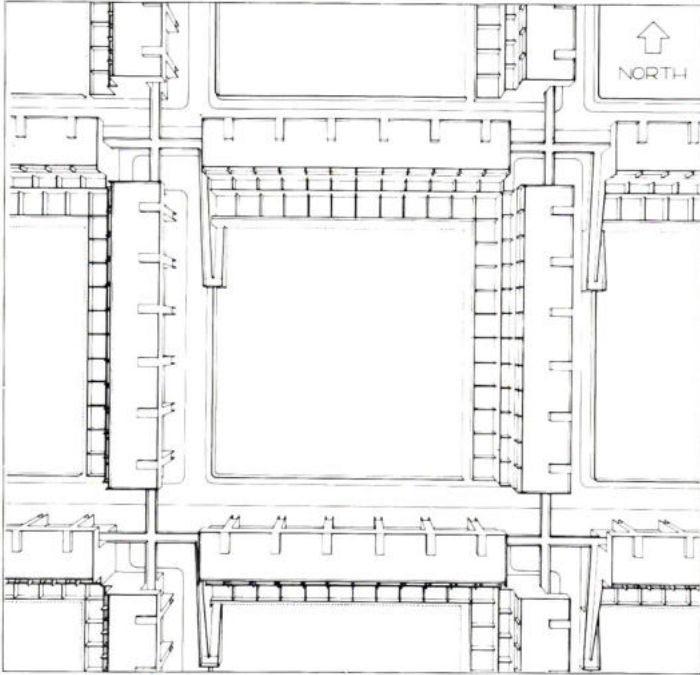

26

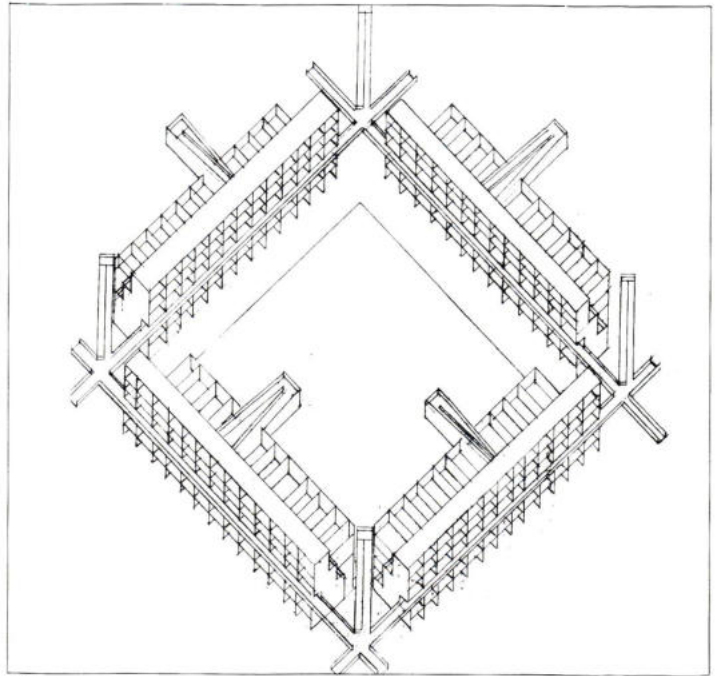

28

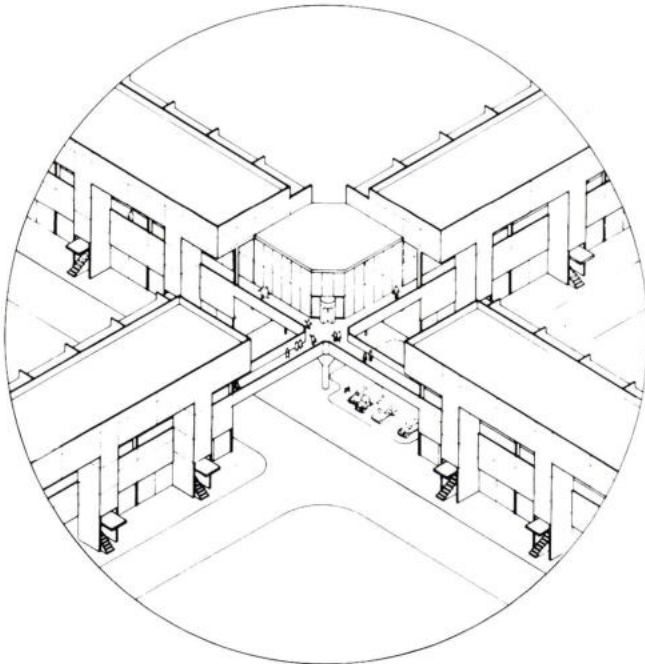

27

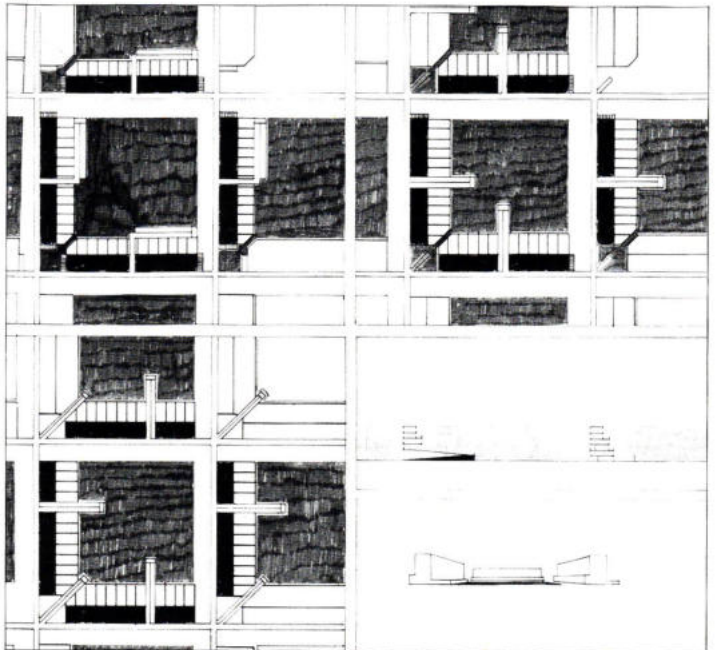

29

26 Runcorn New Town housing,  
England. James Stirling, architect,  
1967. Aerial view of a garden square.

27 Corner between terraces for future  
community buildings.

28,29 Studies for resolving the  
junction between units around the  
squares.

30 Stair towers and two story high  
void at gallery level on the inside of  
the courtyard.

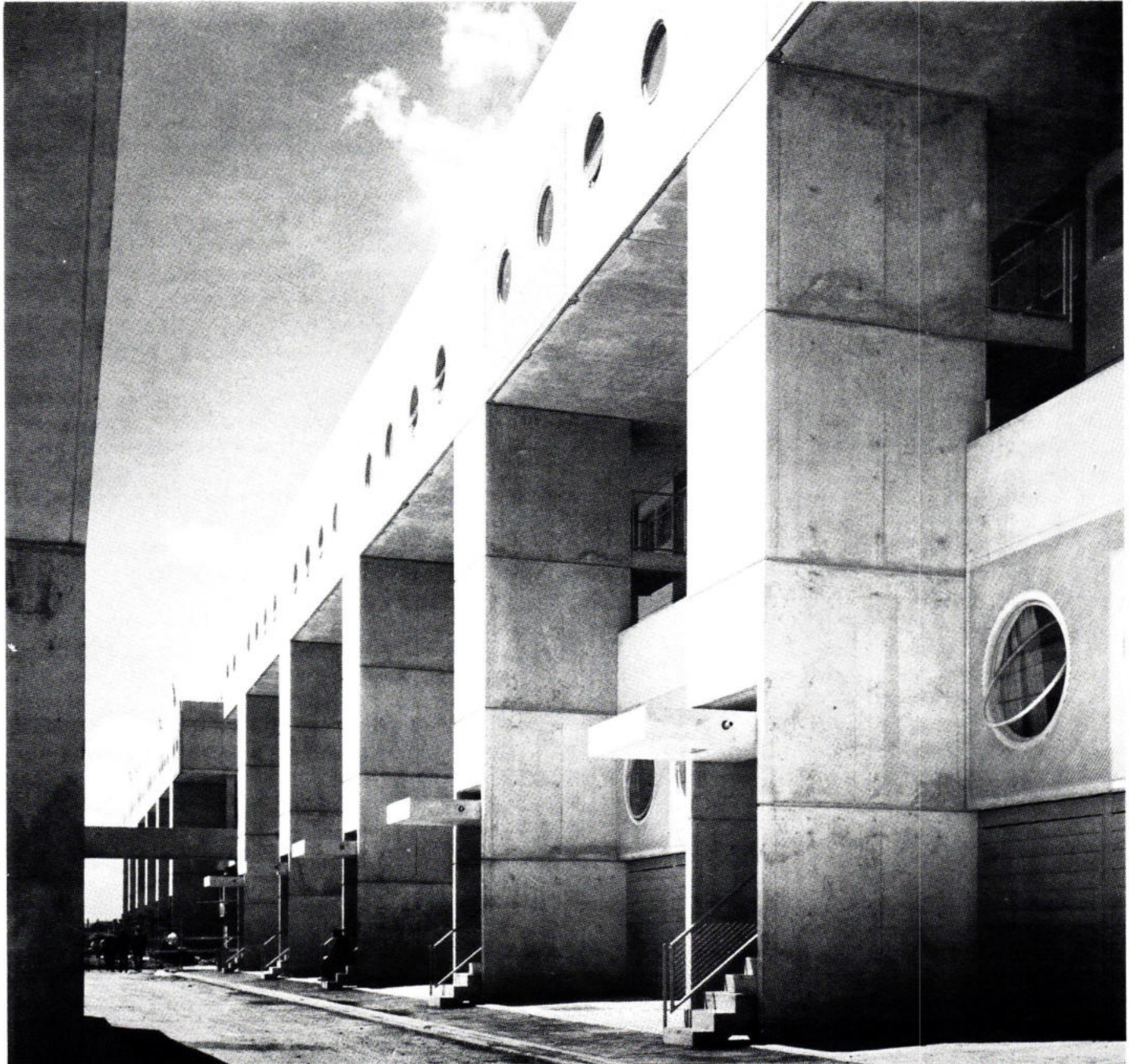

20 as the most powerful architectural elements in the space (fig. 30). The two-story-high void at the gallery level helps only to exaggerate the scale rather than to reduce it. The introduction of the protective glazing at the circulation level might perhaps have helped to relieve this effect. In this way, the terrace sides with their small scale glazing, their extreme horizontality, and the thin blades of the fin walls between units in conjunction with the stepped section are in such opposition to the circulation perimeter as to produce a complete cleavage between the two “L” forms that enclose the squares. As a result, the space is split visually and spatially along the diagonal, in contrast to the traditional London square which is of generally consistent scale all around and of similar elevational treatment.

No doubt these problematic issues of scale will diminish as the trees surrounding the green areas mature. At that stage, the diagonal split of the squares will tend to disappear, the trees becoming the dominant feature of the space. The prospect of schemes like Römerstadt, Siemensstadt, or Kiefhoek fifty years after their realization, makes one realize the critical role of landscaping. The galleries of Runcorn in twenty years will no doubt form a sequence of arcaded streets bounded on their opposite sides by a dense wall of trees, thereby helping to balance the present exaggerated scale of the loggia.

Nevertheless, the over-articulation of individual elements, such as the stair towers and the stepped section and the formal separation of the various systems, vertical as well as horizontal, are ultimately unsympathetic to the shaping of architectural space. The traditional English square is distinguished by the presence of continuous bounding walls. With simple punched-out windows and discrete details the enclosing buildings are not overpowering in scale. The lesson of Runcorn is that the dimension of the space alone will not produce the qualities of the traditional classical square.

In the past, the superimposition of neutral, undifferentiated grids on specific site conditions which tended to distort them—plans like Priene, Miletus, and San Francisco—ultimately forced the grid to appear as an incomplete fragment through the interference of topography. Unique con-

ditions were formed by the collision of the grid with the landscape: a dialectic between the “normal” ground and the neutral grid.

The topography in Runcorn comprises a large hollow or bowl and this shape, interacting with the grid proposed by Stirling, produced in almost all of his studies a parallel fragmentary effect. While Stirling could have chosen to have completed his overall grid by closing off the perimeter squares, this would have produced a complete figure rather than a fragment. In the event Stirling not only engaged the edges of the site, but also let part of the system, the circulation network, extend onto the embankment and physically tie the buildings to the slope, like fingers grabbing hold of the site (figs. 32, 33). There are clearly two different faces to the project; the hard public facade and the soft private side of the fragmented edge in contact with the major topographical element—the landscaped garden (fig. 34). In its present state the scheme comprises two stable sides, to the north and east, which appear as the original edges of the whole, with the remaining sides, on the south and west, constituting the frayed edges. The two, hard edges on the public side are subjected to special pressures: the pedestrian entrance from the town center to the north and the vehicular entrance to the project from the east (fig. 35). Stirling modified these two sides by the addition of “set pieces” forming clearly articulated vestibules. These act as major facade elements, each scaled to the particular approach and experience. The pedestrian entrance is produced by adding two “L’s” back to back; thereby forming a symmetrical gateway to the scheme. On the east side, again using the basic building elements, Stirling splays two of the “L” sections to produce a large, funnel-like entrance space for the automobile approach, responding to high speed movement and the traffic distribution system. These splayed elements must be seen as a single entity with the highway interchange. The access to the project from the town center across bridges at the middle level of the five story units affords an impressive representational approach to the whole scheme, with the double tree-lined walls forming a proscenium for the “vestibule” of the project.

By locating the largest units at grade level and the middle

31 Runcorn New Town housing, England. James Stirling, architect, 1967. View across the elevated footway.

32 Final scheme. Community roads end as cul-de-sac to reduce traffic movement.

33 Final scheme. Contours and tree planting.

34 Diagrammatic site layout. Sketch by Werner Seligmann.

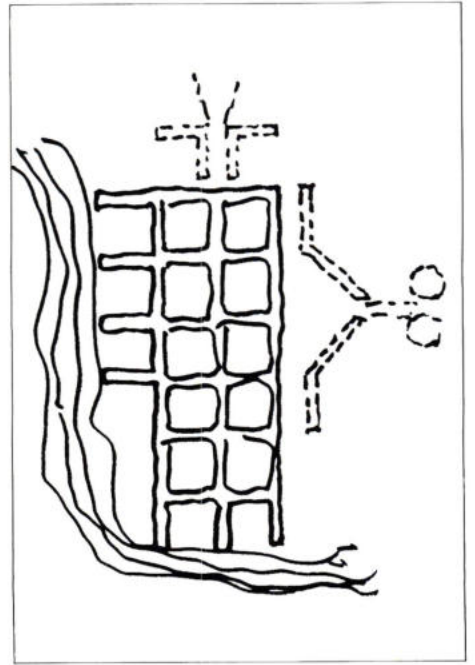
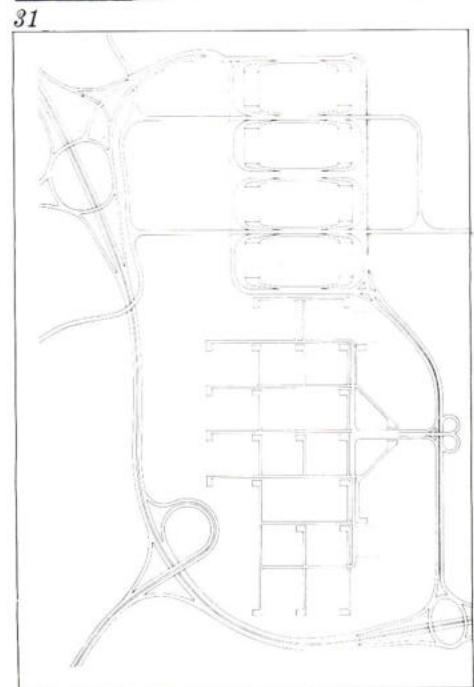
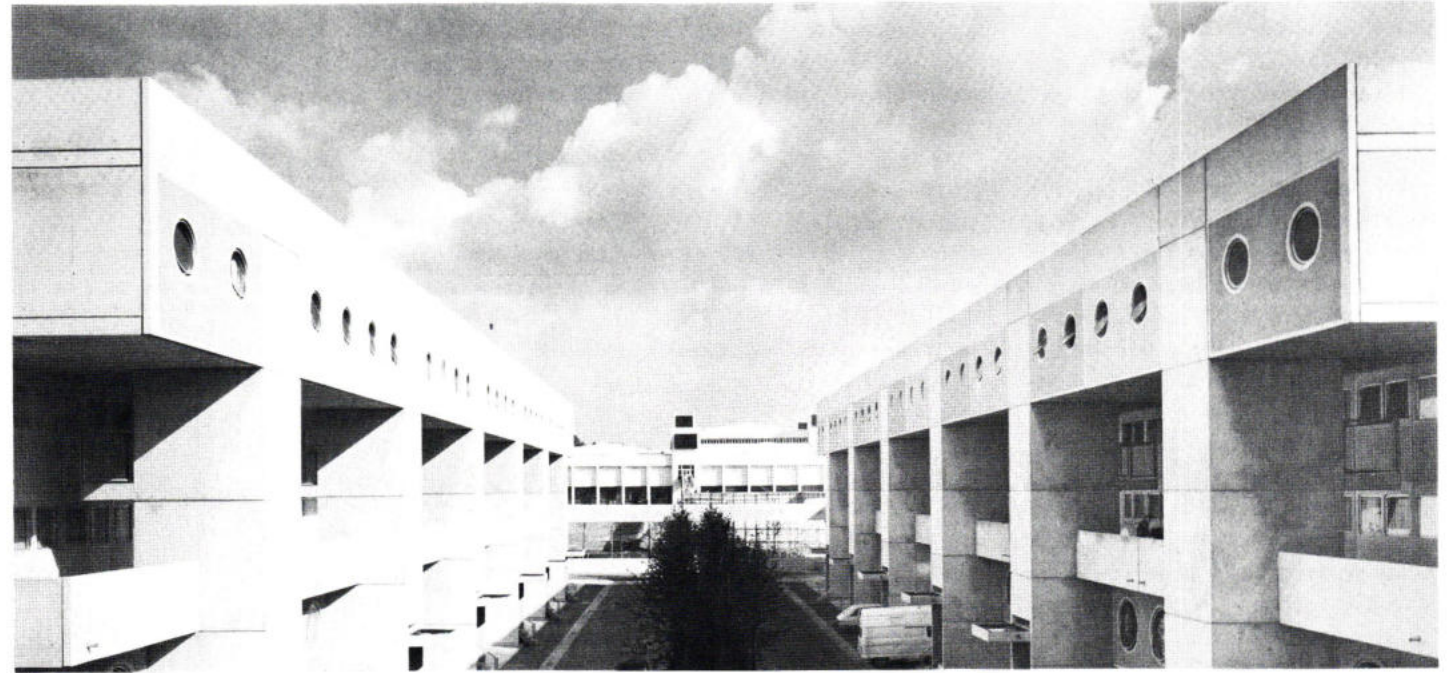

35 Grid diagram. Sketch by Werner Seligmann.

36 Runcorn New Town housing, England. James Stirling, architect, 1967. Final scheme. The elevated footways which increase in width toward the town center.

22

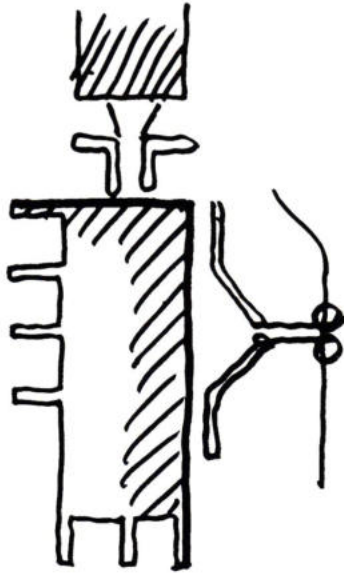

35

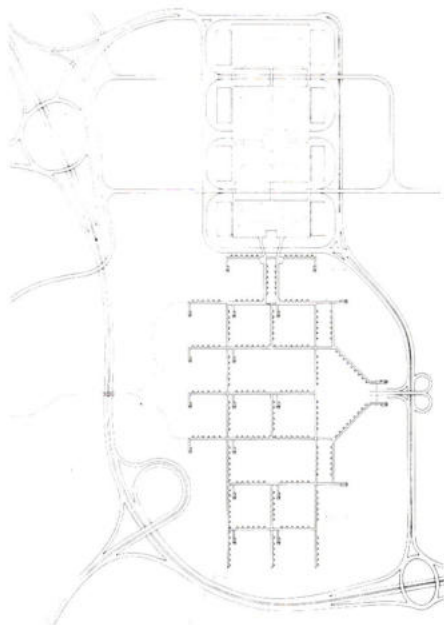

sized units at gallery level and terminating the system with two and three person flats, almost fifty percent of the occupants of the typical section have access at grade. The two person flats on the top are served by staircases in pairs whose only other function is to connect the gallery access to the garages below. Since the stair towers connect to street level one must assume that the street is meant to serve as another access route and this naturally conflicts with the idea of the street in the air.

As a whole, the upper level circulation system is highly questionable and reduces the experience of the project to a relentless movement around the narrow galleries and bridges (fig. 36). Even the distribution from the major entrance "vestibule" to the two principal circulation paths is undifferentiated. The incorporation of the circulation network into the building section does not allow for the accommodation of differing intensities of circulation, a problem that is particularly critical where the scheme connects to the town center and where the major public circulation impinges on the individual access to the units. While the intersections at the corners may take on a special life, one cannot help the feeling that the upper level circulation for much of the project is a symbolic and metaphoric appeal to modern values rather than an actual enhancement of the life of the square.

The integration of historical precedent as part of the equation distinguishes Runcorn from the housing experiments of the 1920s. Runcorn posits an equality between rational design procedure and historical precedent as well as an interplay between quantitative analysis and intuitive response. While the ideas behind the grid may be distantly related to computer technology, the use of historical precedent can be seen as the desire for continuity.

36

## Postscript

Anthony Vidler

The combination of historical sensitivity with the seemingly “computer like” generative potentialities of the grid and its permutations was in the end not enough to overcome the insistent, rationalized typology of the Modern Movement in its first phase. Thus, underlying the pro-historical themes that were in the sixties employed to attack the evident deficiencies of the Modern Movement, were the premises of that movement itself; premises so firmly entrenched within the process of “rationalization” and technical co-ordination that no superficial evocation of past eras could bypass their effects.

If we look at the later work of Stirling, the contradictions of the machine approach become more evident. I would see, for example, the Siemen’s competition—the machine actually taking over architecture and architecture literally becoming the machine—as finally excluding the people that originally the machine analogy was adduced to include. If we look even later in his work—the “crash” of the machine implied by the Olivetti headquarters for example—I think that Stirling becomes aware of this dilemma and attempts to open the machine once more for inhabitation. One might see the recent shift toward a re-evocation of urban and architectural historical motifs as a move away from purely machine analogies to the incorporation once more of culture—and thus society—into an architecture which for so long has been in a sense de-natured by its machine affiliations.

In this context, Runcorn becomes significant not so much for the synthetic virtues of the solution (although, as has been noted, some of these are masterfully displayed), as for its almost polemically transitional nature, proposing problems; and intimating solutions that only ten years later are being fully comprehended. Transitional, that is, not only in the work of Stirling but in the course of modern housing as a whole, for Stirling has even been both the mirror and the focussing lens of the dominant currents in contemporary architecture.

## Figure Credits

- 1,2,25–27,30,32,33,36. Reprinted from *James Stirling: Buildings and Projects 1950–1974* (New York: Oxford University Press, 1975).
- 3,17. Reprinted from S. Giedion, *Space, Time and Architecture* (Cambridge, Mass.: Harvard University Press, 1963).
4. Reprinted from Walter Gropius, *The New Architecture and the Bauhaus* (Cambridge, Mass.: The MIT Press, 1965).
5. Reprinted from Le Corbusier, *Sur Les 4 Routes* (Paris: Editions Denoël, 1970).
- 6,10–16,19–21,23,24,28,29. Courtesy James Stirling.
7. Reprinted from *Probleme des Bauens* (Potsdam: Müller & Kiepenheuer Verlag, 1928).
8. Reprinted from Alison Smithson, ed., *Team 10 Primer* (Cambridge, Mass. and London: The MIT Press, 1974).
9. Reprinted from *The Architectural Review*, November 1962. Redrawn by Andrew Anker.
18. Reprinted from Steen Eiler Rasmussen, *London: The Unique City* (Cambridge, Mass.: The MIT Press, 1967).
- 22,31. Courtesy James Stirling. Photographed by Brecht-Einzig Ltd., London.
- 34,35. Courtesy Werner Seligmann.

“We shall not bulldoze Westminster Abbey”:  
Archigram and the retreat from technology

Martin Pawley

The Beatles were to popular music in the early sixties as Archigram was to architecture.

With the demise of verbal communication there was the demise of wit, critical insight, and poetry. English cool was replaced through McLuhan by hot Archigram.

It was the generation of the sixties.

It was a self-proclaimed avant-garde.

As the Modern Movement died in 1939, so too did this neo-functionalism of Archigram die in 1968.

What remains is the joyless demiurge and the dark side of the English wit—snarkiness.

Enter Martin Pawley whose savage insights are so close and so far away. Only he can perhaps tell us.

For when the noise has died away, does anyone remember hearing any sound?

PDE

Martin Pawley was born in London, England, and studied architecture at the Oxford Polytechnic, the Ecole Nationale Supérieure des Beaux-Arts in Paris, and at the Architectural Association, London. He has taught at the Architectural Association, at Cornell University, and at Rensselaer Polytechnic Institute in Troy, New York. He is now developing a graduate course in low-cost housing for developing

countries at Florida A & M University, Tallahassee. He is the author of *Architecture versus Housing* (Praeger, 1971); *The Private Future* (Random House, 1974); and *Garbage Housing* (Halsted, 1976). Currently he is engaged in the exploration of low-cost construction using containers, packaging, and other waste materials and has recently completed a house built entirely from these materials. He is a frequent contributor to *The Architect's Journal* and *Architectural Review*. His forthcoming books include *The Rise and Fall of Owner-Occupation* and *The American Directory of Reusable Garbage*.

*1 Archigram Opera, May 8th 1975.  
Peter Cook prior to the opening with  
Charles Jencks (right).*



**“We shall not bulldoze Westminster Abbey”:  
Archigram and the retreat from technology**

*The love is gone.  
The poetry of bricks is lost.  
We want to drag into building some of the poetry of  
countdown,  
orbital helmets.  
Discord of mechanical body transportation methods  
and leg walking.  
LOVE GONE.*

Archigram Paper 1, *May 1961*

I remember Archigram the name, because one afternoon of heat the express train (of technology) drew up there unwontedly; it was late spring, May 8th, 1975, to be exact, and the biggest audience at the Architectural Association for a year or two packed in to see the revised tenth anniversary performance of the Archigram Opera, despite the warm weather and manifold distractions of the metropolis beyond the lecture hall door. Lecture Hall No. 1—formerly called “the dining room”—has a strange configuration which I can liken only to a now-defunct cinema in Queen Street, Oxford, which was similarly divided, like trousers. Imagine short trousers seen from the front, the wearer’s legs astride: convert this elevation into a plan and figure the stage as an old-fashioned trouser pocket—not a patch pocket or a hip pocket. In the pocket at the opening of the show stood Warren Chalk, with two packs of cigarettes and a box of matches in his hand fully fourteen years (perhaps to the day) after the publication of the original “mettlesome broadsheet,” *Archigram 1*. Behind him a long, curved paper screen running from the lowest point of the pocket to the opposite side of the waistband. In the area of the trousers reserved for genitalia, on tables piled upon tables, stood a battery of slide projectors, tape decks, and king-sized speaker cabinets: behind them sat Dennis Crompton. Deep in one trouser leg, wearing a polka-dot shirt and rapping with admirers, was Peter Cook. Ron Herron was somewhere about too as the lights dimmed. There must have been two hundred people in the trousers, maybe three hundred. “I suppose I am the oldest member of the group,” began Warren, “and I’m going to introduce all this stuff because it will take hours. . . .”

*Part One*

Loud funky music broke in, louder and with better quality reproduction than ten years ago. Then, with the stage bare, the slides opened up exploding on alternate sides of the screen. Pictures of the wild bunch: Warren himself, Peter Cook, Ron Herron, David Green, Mike Webb, and Dennis Crompton; then the junior team, Colin Fournier, Ken Allinson, Tony Rickaby, and others I could not recognize; then the precursors and chroniclers, Buckminster Fuller, Cedric Price, and Reyner Banham. Pictures of them spanning a thousand years in the memory; some hanging loose in California, some uptight with short hair and urgent conversation (about what to do before they realized this was it?) at the dawn of real time. How sentimental. How tragic the atmosphere. The music changed to Richard Strauss as the slides dug deep into the roots of the Modern Movement, to the images that launched a thousand careers (even those that floated)—Mendelsohn, Scharoun, the Taut brothers, the Constructivists, de Stijl . . . Back, back to the Ashmolean Museum in 1960, to Northgate Hall, Oxford, to Folkestone, to the old ICA, to the time when they bought leather coats to celebrate winning a competition. A slide flashed, BUT WE TURNED ELSEWHERE.

*Almost without realising it, we have absorbed into our lives the first generation of expendables. . . . Foodbags, paper tissues, polythene wrappers, ballpens, EP’s. . . . So many things about which we don’t have to think. We throw them away almost as soon as we acquire them. Also with us are the items that are bigger and last longer, but are nevertheless planned for obsolescence. . . . Our basic message? . . . That the home, the whole city, and the frozen pea pack are all the same. . . .*

Archigram 3, *Autumn 1963*

And now came the real sources of their inspiration; pictures from magazines of zeppelins, submarines, spacecraft, molecules, transistors, and girls. Pages from the various issues of *Archigram* flashed on and off (now it was steel bands and grand funk again) until the real stuff came pouring through—the rich, unbelievable schemes, the effortless translation of technology into architecture. “Machine-monster worry?” said a slide. “Then package it!” What did

28 that mean? Too late now to find out. It always was too late. *They* know—or at least they *knew*—but now it is buried beneath projects for motorized tents. “Capsules become pods,” explained a slide knowingly, whilst another exclaimed “In Oxford Street the architecture is no more important than the rain!” In five years they envisioned an entire landscape of super-humanist equipment; an existential technology for individuals that the world will, in time, come to regard with the same awe as is presently accorded to the prescience of Jules Verne, H. G. Wells, or the Marquis de Sade. Futile to complain (as many do), “But they never *build* anything.” Verne never *built* the *Nautilus*, Wells could hardly drive a car, and the Marquis de Sade? Well, he was in prison for most of his life.

#### *Debate*

It was impossible to take many notes that day. I sank into a reverie, filled with shame at my failure to recognize genius all those years ago. Now I understood the meaning of the stream of visitors to Aberdare Gardens over the years; those backpacking Brazilians, translucent BBC men, uncomfortable professors (all too aware that those new luminaries were exactly like the students they feared at home): all of them had been more honest and more grateful than I, who had been merely picayune, jeering at the interstices in Peter Cook’s net of words whilst mighty fish slipped away to Germany, to Italy, to Japan. Now, I reflected, he has his revenge. Svengali-like impresario bestriding the London art scene like a colossus, welding drawing board and palette into a sacrifice to be laid at the feet of hobgoblins who have themselves parlayed Palgrave’s *Golden Treasury* and a little antiquated music hall technique into influential careers. . . .

*The building has been designed large enough to include its own component production units. These manufacture moulded reinforced plastic panels, which are conveyed, folded up, to their positions in the structure, and then opened out to form usable floor space. . . . Transport consists of raw materials arriving at one of the ports and being pumped through pipelines to the site production units. Plant 1. produces main supporting structure components (prob. based on Bucky Fuller’s “Aspersion*

*Tensegrity” whereby a standard tensegrity structure will erect itself in the air by tensioning its outer edges). This would form the transparent, weather-resistant skin. Archigram 4, 1964*

Reading this extract from Michael Webb’s account of his House Project, one relives the wonderment of discovery. The Archigram group, in their heyday, dismissed the limited capabilities of the construction industry with the same impatience as Jacques Maisonrouge (Chairman of IBM) displayed in his famous announcement that “The world’s political structures are completely obsolete. They have not changed in at least a hundred years and are woefully out of tune with technological progress.” At one time Archigram and the multi-national corporations were made for one another; there is perhaps a hint of panic in Webb’s “prob. based on Bucky Fuller . . .” but compared to the absurd posturing of Archigram’s detractors, innured as they were in “the world’s political structures,” this is trivial indeed. Of housing, Archigram said in 1966, “Housing is a crust of capsules hung on the diagonal tubes.” Who would have the nerve to define it thus now? Their past is *still* our future, the triumph of reaction can be but temporary. Indeed we can still only deal with their already ten-year-old vision by way of jokes reminiscent of the kind of futile opposition offered by literati to the coming of the railways. Defensible crust? Vandalism in the diagonal tubes? When Instant City really camps in Death Valley who will be churlish enough to mention Charles Manson? When the Archigram dirigible *Rupert* greets the citizens of Bournemouth who will be so tasteless as to breathe the name Hindenburg?

*Walls, ceiling, floors—in this living area—are wall, ceiling, and floor conditions which adjust according to your needs. The enclosures of the living area are no longer rigid, but adjustable, programmed to move up and down, in and out. The floor state too is variable. At particular points the floor can be made hard enough to dance on or soft enough to sit on. Textures and colours depend on the user’s taste at any moment. Seating and sleeping arrangements are inflatable, and details such as weight of bed-covers and number of cushioned elements are controlled by the user. Bed-covers*

*2 Archigram Opera, May 8th 1975.  
Dennis Crompton above an array of  
slide projectors.*

*are not really necessary, as the living area, which is air-conditioned, can have special warm-air areas—but some people might like a token cover.*

*The old concept of a movable chair has become a travelling chair-car. The model in the living area is designed on the hovercraft principle, and can also be used outside for driving around the megastructure city. The bed-capsule (not included in this display) can also change to a hovercraft and run outside. The crucial issue of privacy versus general communication—which dogged designers of the open plan—is effectively resolved in Archigram's design. The robots can shoot out screens which enclose a required area of space. The ceiling lowers at this point, and whoever requires it has a private area. The robots are movable—on wheels. They do most of the work.*

*Refreshments can be drawn from them. They contain a compressor for blowing up the inflatable furniture. They also have an element for extracting dust from the living area. The robots also incorporate radio and television—including favourite movies and educational programmes—which can be switched on when you want them. The television is, at the present stage of development, seen on wide screens, and can be programmed so that viewers are surrounded by realistic sound, colour, and scent effects. The controls can be worked by a gesture as delicate as that of batting an eyelid. Every day the robots must be taken to the service wall end of the living room to refill with water, air, and the rest, and to deposit dust and rubbish. This service wall connects with a vast service stack, shared with the megastructure city, which is one of the key facilities of Archigram's structure. Items such as clothing (which is envisaged as disposable), food, and milk are piped into individual living areas, and can be changed or returned by the same system, or disposed of when finished with by a pipe leading to the shared disposal system.*

*Each living area is fitted with ultrasonic cooking equipment for cleanest, quickest cooking, but otherwise arrangements will depend on the interest of the cook. Cooks will be able to simulate the physical conditions needed for perfect open-fire cooking, slow-oven baking, barbecuing and spit-roasting.*

*The design of the living area goes some way towards*



*3 Archigram Opera, May 8th 1975.  
Warren Chalk prior to delivering the  
introduction, with Ron Herron (left  
above).*



*allaying the widely-held fears that the future points inevitably to standardisation and conformity of living accommodation. The purpose of the Archigram scheme is to give people a level of personal choice and personal service which as in past decades has only been approached by the richest members of society.*

*Catalogue for Harrods 1990 room set, designed by Archigram, 1967.*

Their certainty in those years was unbounded. Verging occasionally on the Monty Pythonesque (as with the hovercraft bed that can “run outside”), it nonetheless cut through the nostalgia of that May evening in 1975 like a knife. I made a note in the darkness punctuated by the bright flash of slides: they did their best work at one of those times when visionaries believed that what they had drawn and described had really happened. They were of course aided in this belief by critics who—lacking any faith in the “invisible hand” of the marketplace—believed equally strongly that only their opposition stood between the Archigram blueprint and its realization. Critics always believe that, it is at once the force and the futility of their craft. The only real antidote is the enlargement of experience.

The resemblance of EXPO '70 at Osaka to an Archigram metropolis in the flesh has been noted more than once. Indeed, the only thing at Osaka that was not Archigram-like was the tiny Archigram “Dissolving City” exhibit tucked away in the roof of Kenzo Tange’s gigantic Theme Pavilion. There, surrounded by pods and capsules, gloops and nodes and robots that were not mock-ups made of painted blockboard, the intended question and answer tunnel stood silent, none of its complex electronics installed. No foreign visitor ever asked a question or obtained an answer from it—a fact never mentioned in published versions of the “Dissolving City” scheme. When first confronted with the Japanese version of what Archigram had been drawing for so long, one could only gasp at its enormous scale and technical completeness. I remember wondering what the Archigram team themselves thought whilst being led by Japanese hosts along the moving ways of Instant City EXPO to the conference center where Dennis Houghton spoke. The impact must have been as shattering

as Cavour’s first conversation with the Selenites, or Professor Arronax’s introduction to Captain Nemo aboard the *Nautilus*.

*The government of Monaco have asked the Archigram Group of London to proceed with their design for the new entertainments centre on the sea front at Monte Carlo. This project was recently the subject of an international competition and the winning project by the Archigram Group was judged by Pierre Vago, René Sarger, Michel Ragon, and Ove Arup. It was the only English entry invited into the final stage together with twelve other projects (by architects from France, Spain, Poland, America, Finland, Norway, and Germany). The building will be totally underground with a large uninterrupted circular space 250-feet in diameter. Almost any show can be provided including ice hockey, the circus, large banquets, theater, audio-visual exhibits, go-karting and sports. To make this possible, Archigram are designing a series of approximately twenty different robot-type machines which plug-in to a service grid above and below. Everything, including the seating, lavatories, stages, and walls will be movable and the “architecture” of the building will depend upon the wishes of the producer of the show. There are six entrances—so the layout of the building can be constantly changed. The entire building is seen as a giant cybernetic toy in which the architecture plays a similar role to the equipment in a television studio. Total cost of the scheme is estimated at \$6,000,000 and building work is expected to start late in 1971. Archigram Press Release, 1970.*

The projected “Features-Monte Carlo” structure would have been—had it been carried out—the largest underground dome in Europe since the German rocket launching silo built at Wizernes in Northern France in 1943 was destroyed by bombing. Archigram did not think of it like that: to them it was the basement of a “plug-in land beach” wired up to enable you to “dial for drinks from anywhere in the park.” I remember a brief conversation with an acoustics architect about it. “Hmmm,” he said, “twenty robots, that’s eight miles of integrated circuits . . . say \$16,000,000.”

32 *Intermission*

After a solid hour of bright images and good music, an intermission was called on May 8th. The lights came up, curtains were pulled, and Peter Cook, a bunch of magic markers in his hand, came over for a chat. There had been a rumor about for a week or two that—owing to the adverse economic climate—the Archigram office was to close down: I taxed him with it. “Well, we thought about it, but we decided what the hell, we’ve been going this long, might as well keep going,” he explained.

If Archigram nearly made the big time with “Features-Monte Carlo,” there was still just enough steam left that night to keep Jacques Maisonrouge hovering at the back of the hall with a contract in his hand. That intermission was remarkable; there must have been three hundred people in the trouser-hall with a temperature not far short of 90°F, but few of them left, even to get a drink from the bar. Cook (who is generally private in public and public in private) described a lecture tour from which he had recently returned; Copenhagen, Aarhus, New York, and the East Coast. No flak anywhere, not even at M.I.T. “They really hated us there in the old days.”

*Part Two*

Instead of music and slides, Part Two offered a speaker—Peter Cook himself—more slides, and the strains of Delius. “Yes, Delius,” he began, “it never has a theme that develops anywhere: it just goes on and on. Perhaps sickening. Who knows?” Jacques Maisonrouge does, he slips the unsigned contract back into his pocket and returns to his black chauffeur-driven Cadillac. “The heliport,” he grits. And just in time, for it is *conceptual architecture* at last. As ART NET is to ARCHIGRAM, so is CONCEPTUAL ARCHITECTURE to ZOOM. It is what architects (and would-be architects) do when they finally *believe* that the drawings will have no building, that intercourse with the drawing machine will produce no pregnancy, that the distance separating Captain Nemo from the USS *Nautilus* (SSN 571) is so immense that it is not even worth attempting.

*MAYBE ARCHITECTURE IS JUST A GAME? Maybe*

*the historical back-and-forth of morals and symbols dressed in architectonic styles is a game being played out? So what's different about today? What's new? Every so often our frontiers are so greatly extended by science and invention that the way to live takes a leap. Sometimes architecture is there waiting to help, or sometimes playing in its own corner. Technology? Now let's see, hear, breathe, feel worlds outside our own world. . . .*

*Peter Cook*

*Control and Choice. Reprinted in A Continuing Experiment Architectural Press, 1975*

“This is a bland piece of land,” Cook continued as the strains of Delius began to fade, “but sneakily something happens (next slide), and it is interrupted by a crevice (next slide). Sudden elegance in the crevice, then the land continues (next slide) . . . Such paradoxes are the milk from which one draws.”

An orchard. “The orchard became (next slide), dare one suggest it, a kind of megastructure *manqué* (next slide), in this case, mechanical trees.” A structure. “One couldn’t resist quirking the plan even before one began (next slide) cancerously adding the lumpen stuff to it. The tactile quality of satin. . . . The cream as it folds. This is beyond architecture, honestly it is.” There is a strange interjection from the audience in Italian, a slight flicker of terror in Cook’s voice, but he continues: “I found myself in Edinburgh at an oil conference. Most of it was moralistic. . . . What I call the Celtic fringe which includes Norway, Canada, and certain parts of Alaska.” A second *spontaniero* from the audience offers “Anchor an ocean liner up there!” But he too is ignored as the speaker pushes on into broad comedy with deliberately Scottish pronunciations of “burns” and “bairns.” Cook conceptualizes rapidly; he illustrates and evaluates architectural manifestations such as THE LUMP (Mont St. Michel), THE HEAP (a mound of wrecked cars), THE MOUND (“One of the parts of *Archigram 5* was the discussion of the molehill”), and finally THE SPONGE “with orifices.”

By eight o'clock the opera has been running for three hours,

there are still forty or fifty people standing. Cook has been speaking for two hours and shows no sign of exhaustion; the paper screen is covered with multi-colored drawings made with magic markers and still the slides are coming. “Archigram,” he says, “went through two stages of development. First the mechanisms, and second *this architecture of the thing to be so far beyond one’s experience of other objects as to be something else again.*” While he draws there are intervals of Haydn.

*Dear Sirs, We looked at Peter Cook talk on the TV program and thoroughly enjoyed his talk. He talks a load of plain common sense. Lets hear more from him. Now we think that the Royal Institute of British Architects should have a surgesttion box [sic] for the public to give their ideas to. We think it should give the address outside the post office where the public could write if they wish to. Here some ideas to Help the architects.*

- 1) *Never build to many houses in a turning for the public to walk to the next road the most should be 10 houses never 200.*
  - 2) *Have more slidding doors in the homes. They better in every way. No banging like the Japan have. Never have open DOORS.*
  - 3) *Make the Bathroom the Best place for health and cleanness. Have the toilet in a separate room with the bath incace a person is in the bath or shower and people cannot get to the toilet.*
  - 4) *Do away with dirty old cellars. Some people full them up with old junk.*
  - 5) *Bring sunlight into Homes never Hide with Great Big Walls. Have slidding walls.*
  - 6) *Schouls Built with plenty of sport rooms for children to get rid of energy if they wish. 14, 15–16 years old. and so on with more new idears to help. So from our surgesttion box idears to yours.*
- Letter to the R.I.B.A. Journal, 1972.  
(Some spelling corrected.)*

do as long as they don’t start chanting.” He has had audiences of all kinds since he started, at first they were speechless; then they got angry. At the Folkestone International Dialogue of Experimental Architecture in 1966 he was slow-handclapped off the stage. In Amsterdam, in 1970, dull-witted ideologues tried to prove that he *had* signed a contract with Maisonrouge—if not with the Green Berets. In Paris, in 1971, a whole audience walked out. But like any performer, and of the Archigram group he is the *only* performer, he has had good times too—especially lately. Now the audiences are speechless again; they turn up in droves but they no longer heckle or question as much as they used to. They sit (or stand) and listen and applaud and go home and read in the papers that hopes for nuclear power have dimmed; that gas prices will rise again; that inflation has reached fifteen, or twenty, or twenty five percent; that public housing starts are the lowest for eighteen, or twenty, or twenty-five years; that unemployment is still rising; that food is poisoned; that cars are smaller than ever; that former astronauts are working as evangelists; that mad people keep on trying to kill the president; that—and this is only if they search hard in the most obscure papers—brilliant young architects are selling their drawings of the brave new world to the galleries and museums of the craven old in order to make a living.

*Machine-monster worry? Too bad. No one’s going to package it now. The idea of an expendable environment is still somehow regarded as akin to anarchy. . . . As if, in order to make it work, we would bulldoze Westminster Abbey.*

**WE SHALL NOT BULLDOZE WESTMINSTER ABBEY.**

Archigram 3, Autumn 1963

Figure Credits

1–4 Courtesy Martin Pawley

The Opera ends at last on the same note of funky music as it begun. There were no questions and the trouser-legged hall slowly emptied as the roadies packed up projectors and tape decks. “I don’t mind,” Cook had once confessed, “what they

4 Archigram Opera, May 8th 1975.  
A small section of the audience  
during intermission. After two  
hours, forty or fifty of the audience  
were still standing.





## Classic and Neo-Classic

Joseph Rykwert

Behind that elusive late eighteenth-century sensibility generally termed “neo-classic,” there resided a set of shared assumptions about the primacy of the ancient world and its later exhumations. They concerned proportion, the correct use of the orders, the archeological interpretation of ruins, the niceties of Vitruvian interpretation, general ideas of beauty, imitation, propriety, fitness, and so on. They were subsumed from the mid-seventeenth century on, and especially in France, as a body of ideas loosely understood by the 1670s under the heading *classic*. From such ideas, differently codified and transformed by the Enlightenment, the *neo-classic* was developed.

Always bound up with the didactic—the need to teach and to reconcile a unified doctrine—these ideas found a ready catalyst in the Academy; that is, the first formal state-instituted Academy of Architecture founded by Colbert for Louis XIV in 1671. Set down with geometric certainty by the first director, François Blondel, and almost immediately challenged by the natural and inductive science of Perrault, the notion of classic soon embraced the very debates and tensions that threatened to destroy it from within—debates that continued throughout the next two centuries and that, in one form or another, underlie many of the premises of Modern Movement theory and design.

In this essay, Professor Rykwert has revealed the complexity that characterizes the origins of the movement that, in later interpretations, has often seemed so dry and dogmatic. His cosmopolite outlook has allowed him to penetrate the truly internationalist nature of the classic enterprise, as well as its hermetic underpinnings. For historians have only recently begun to come to terms with the long buried traditions that stemmed from the flourishing alchemies, cabbalas, and mysticisms of the fifteenth and sixteenth centuries—that culture so profoundly explored by Frances Yates in her various studies of the hermetic enlightenments of those years. Positivist interpretations of science versus magic, of reason versus faith have continued to deny to the English Enlightenment of fifty years later any of these fabulous tendencies. Indeed, for contemporaries, the forms and proportions of Solomon’s Temple, the mystical number systems, and the handed down tradition of masonic architectural history itself were as dominant and inseparable from the idea of classic architecture as any well-known antique types.

Rykwert’s preliminary sketch serves to outline the program for much further research; a great deal is already contained in his forthcoming book. *Oppositions* publishes this essay not only as an introduction to Rykwert’s painstaking investigations, but as a chapter in the search for the critical relations between theory and

practice in history—in this instance, a theory and a practice that bears fundamentally on our own, bound as we are to take up a position regarding the powerful Western architectural tradition called classicism, a tradition that, for better or for worse, still exercises a deeply formative influence on our culture. AV

Joseph Rykwert was born in Warsaw in 1926 and received his architectural education at London University and at The Architectural Association School of Architecture. He has lectured and taught at many schools including the Hochschule für Gestaltung in Ulm, Germany (1958); Columbia University, New York; Harvard Graduate School of Design; Massachusetts Institute of Technology; The Royal College of Art, London; Cambridge University School of Architecture; Princeton University; the Berlin Technische Hochschule; the Universities of Naples and Palermo; and The Institute for Architecture and Urban Studies, New York. He is presently Professor of Art at the University of Essex. His numerous publications include *On Adam’s House in Paradise* (1972); *Parole nel Vuoto* by Adolf Loos, ed. Joseph Rykwert (1972).

1 Arthur Hacker, *The Sleep of the Gods*, 1894.



The words “classic” and “classical” suggest authority, discrimination, even snobbery—class distinction, in fact. “Neo-classical” is associated with revolution, objectivity, enlightenment, equality. In this essay I propose to examine the growth of these associations, particularly as they apply to architecture.

The birth of what we now call “neo-classicism” was part of a cataclysmic change in the nature of society and in ways of thinking. Many of the ideas that were forged during this upheaval are still with us. Disguised by their apparently rational and objective formulation, they are sometimes dangerously inhibiting. But ignorance of their true nature may often prevent us from welding them to our own use.

At the height of the period which is usually called “neo-classical,” the term was as yet uncoined, and even when the period was on the wane, its proponents simply saw it as synonymous with the “right,” the “classical” manner. In a conversation recorded on 2 April 1829, Goethe, perhaps the greatest poet of his age, expressed his contempt for the new French poets of the time: “I call ‘classic’ what is healthy, and ‘romantic’ what is sick. . . .,” and he adds, “most of what is new is not romantic just because it is new, but because it is weak, sickly, and diseased, and the old is not ‘classic’ just because it is old, but because it is strong, fresh, jolly and healthy.”<sup>1</sup>

Goethe was using the words “classic” and “romantic,” which constantly escape definition, to express prejudice, a usage still with us.<sup>2</sup> Such prejudice may be romantic-bad and classic-good (Jean Cocteau say, or Stravinski), or vice versa (Frank Lloyd Wright, or John Ruskin before him). While the word “romantic” acquired its implications only a century or so before Goethe used it in the way just quoted, the word “classic” has a much older history. Its modern associations still echo its original meaning. The word refers to an ancient tradition. The sixth king of Rome, Servius Tullius, graded all Roman society into six groups called *classes* according to their income; all were expected to contribute money to the defense of the state, except the lowest, the *proletarii*, who had no money to contribute and therefore could only give their children, their *proles*.<sup>3</sup> Ancient writers derived the

2 Sebastiano Serlio, Tragic Scene, wood-cut.

3 The Louvre, Paris. Claude Perrault, architect, 1664–67. The eastern facade.

40



2



3

word *classicus* from *calare*, “to call” (*classicus* was a contracted form of *calassicus*); the word was even applied to the trumpets with which Roman assemblies were summoned, and this meaning was retained throughout the Middle Ages.<sup>4</sup> By the time of the late Republic, however, the word *classicus* was no longer used of the members of any class but the first, or the richest.<sup>5</sup> Writing about 160–170 AD, the grammarian Aulus Gellius makes use of these words as terms of literary criticism, taking them very much for granted. Certain turns of phrase and syntactic quirks, he observes, suffice to show whether the writer is *classicus* and *assiduus* or *proletarius*.<sup>6</sup> Then, in the Middle Ages, the word “classic” was replaced by “canonic,” from the Greek word *kanon* meaning a rule (also a ruler, and even a T-square or set square), and hence a canon was the law which regulates, which upholds what is best: the word “classic” returned not only to the old meaning of war trumpet, but also came to mean a peal of bells, a summoning noise, in the ancient sense. The Italian humanist writers, as may be expected, had restored the word *classicus* to its ancient meaning by the end of the sixteenth century.<sup>7</sup> The French followed, and by the end of the century, an English writer could speak of “classical and canonical” authors, using the medieval and the ancient terms as synonyms.<sup>8</sup>

By the seventeenth century, *classicus*, “classic” meant not only excellent and choice, or first-class, but also antique; the antique had by then assumed the role of an unquestioned and unquestionable model of excellence. Not only writers, painters, and architects, but also statesmen and religious reformers based their practice or policy on the emulation of the antique. The antique meant the republican Rome described by Livy or Cicero to some; to others it meant the Imperial idea extolled by Virgil and Ovid; yet others wanted a return to the first flowering of the “Peace of the Church” under Constantine which Eusebius had eulogized.

Clearly the word “classic” has a variety of implications in different contexts, even if it is taken in the sense of “ancient and exemplary,” which is now commonly given to it. And clearly, too, the implications of authority and distinction are part of the very make-up of the word.

“Neo-classicism” is more difficult to circumscribe. It arose as a term of abuse at the end of the nineteenth century. “A man must be a scholar before he can make neo-classicism even tolerable in art,” writes an anonymous Times correspondent in the early 1890s (he is criticizing a mediocre painting) (fig. 1).<sup>9</sup> At the same time, however, in France and Britain particularly, neo-classicism was a literary *soubriquet*. But if you were to take a look at current dictionaries, you would find that the German *Grosser Brockhaus* takes it to refer to the more sober twentieth-century architecture (Auguste Perret, Adolf Loos, Mies van der Rohe, Peter Behrens, Gunnar Asplund), while the French *Grand Larousse Encyclopédique* treats it largely as a musical movement, involving Weber and Schubert, but also Mendelsohn’s rediscovery of Bach, the early work of Saint-Saëns, and finally Stravinski.

But the “neo-classicism” which is the subject of this essay is not the matter of these definitions, nor yet is the twentieth-century literary movement that involved T. E. Hulme, Ezra Pound, and T. S. Eliot, nor even the French brand: Stravinski’s later ballets, “Satie and le Six,” “Coc-teau and the Synthetic Cubists.” The term is used in a more conventional way to describe the architecture (though it may be used equally for all the visual arts, and even for literature and music and the minor arts) of the second half of the eighteenth century, and particularly as the eighteenth century passed into the nineteenth. Many years ago Sigfried Giedion pointed out the difficulty of dealing with neo-classicism in the same way that one deals with most styles in the history of art. Taken *en bloc*, it presents such a curious divergence of aims, such a variety of formal vocabularies, that it has none of the subconscious, internal coherence which historians demand of a style. It may even be seen (and he has interpreted it like this) as a movement concerned with surface manifestation only, operating as a wallpaper pasted over an uncomfortable crack in history: that between the Baroque and the Romantic period.<sup>10</sup>

Whatever the phenomenon was, movement or style, it had a separate and quite different existence from that emulation of antiquity—a “neo-classicism” by extension—which dominated European thinking since the beginning of the

fifteenth century: the literary, figurative, monumental remains of Republican, Imperial, or Early Christian Rome which were not always correctly identified by the men of the Renaissance, whose stylistic criticism did not always go beyond that of their medieval predecessors.

For many centuries, the temporal power of the Papacy was justified by a lengthy document, the Donation of Constantine, which was widely accepted for half a millenium as a fourth-century document. Then, as the fifteenth century drew on, various ecclesiastics attempted a stylistic criticism of it, until in 1517, in a frontal attack on the abuse of Papal power by a Neapolitan humanist, Laurence Valla, it was roundly declared a forgery.<sup>11</sup>

In the same way, the monuments of antiquity which littered many of the older towns, and Rome most conspicuously, were the subject of reappraisal and criticism. The baptistery of Florence Cathedral, for instance, a building erected in part in the fourth century, in part in the earliest medieval period, was held to be a temple built by Julius Caesar until the eighteenth century, in spite of some tentative scepticism.<sup>12</sup>

Other buildings, particularly the more conspicuous ancient ruins, were considered more carefully. The few architectural texts—the treatise of Vitruvius, passages in Pliny the Elder’s *Natural History*, the letters of his nephew Pliny the Younger (with their elegiac descriptions of his two villas), the lives of various Emperors which recounted their building activities—all were read for evidence about Roman (that is antique) building generally, and matched against the ruins, particularly the more prestigious ones in Rome itself.

Throughout the fifteenth, sixteenth, and even seventeenth centuries, the assumption was current that antiquity was unified and homogeneous. Of course, antiquity had evolved from “rude” beginnings; but it had been devised by the Egyptians and perfected by the Greeks until it achieved its apogee in the art of Imperial Rome, whose vestiges, such as the triumphal arches and the temples on and around the Roman Forum were taken as evidence not only of the de-

4 The Five Orders according to Sebastiano Serlio.

5 The Doric Order according to John Shute, c.1563.

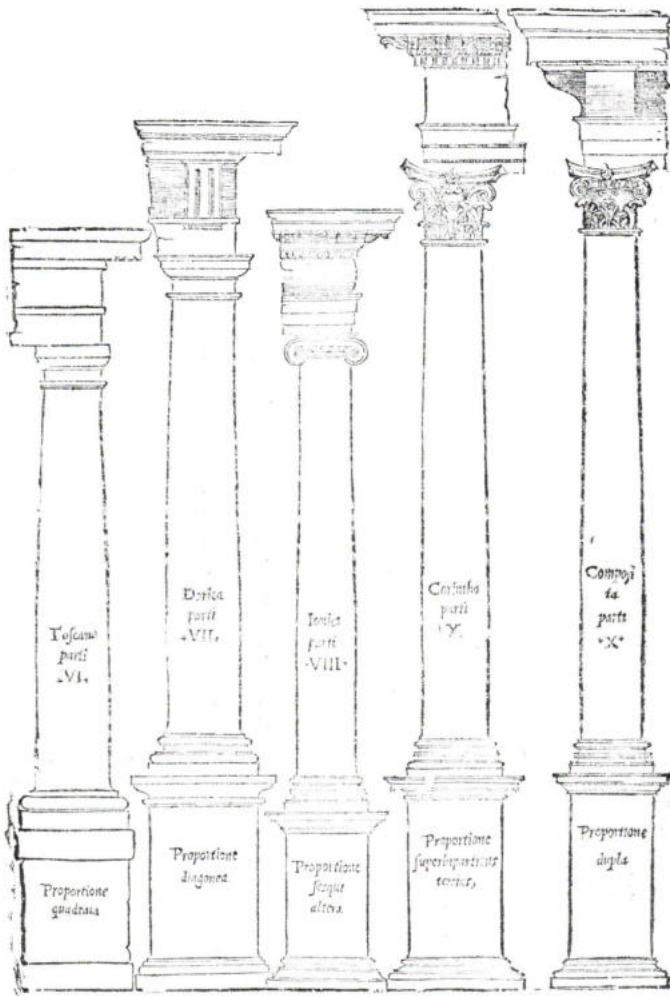

4

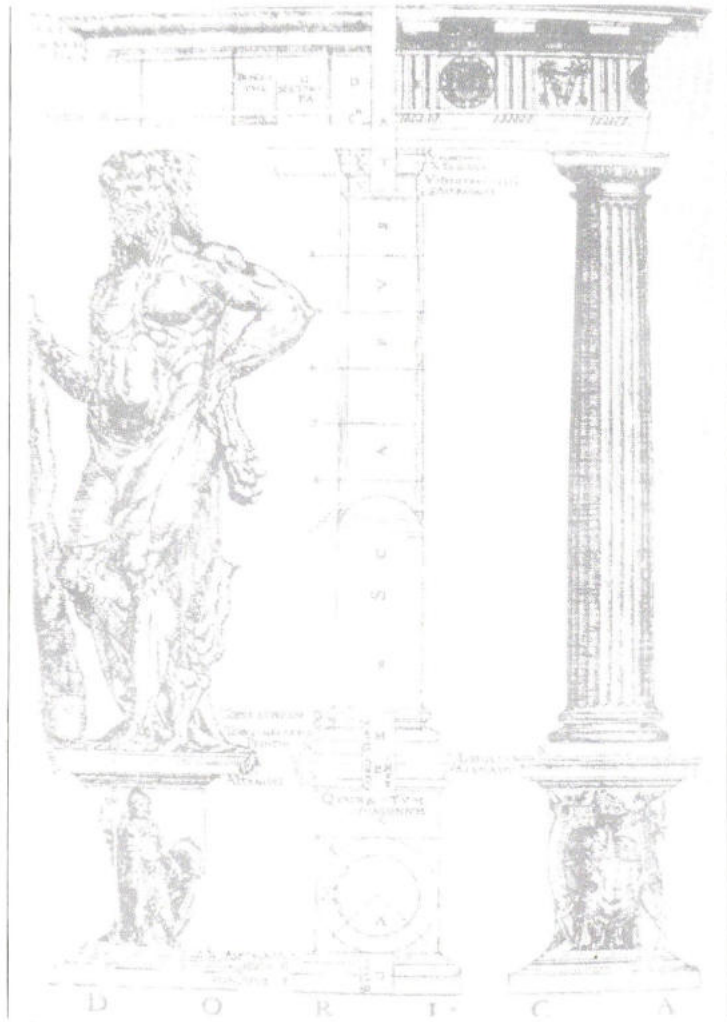

5

6 *The Ionic Order according to John Shute, c.1563.*

7 *The Corinthian Order according to John Shute, c.1563.*

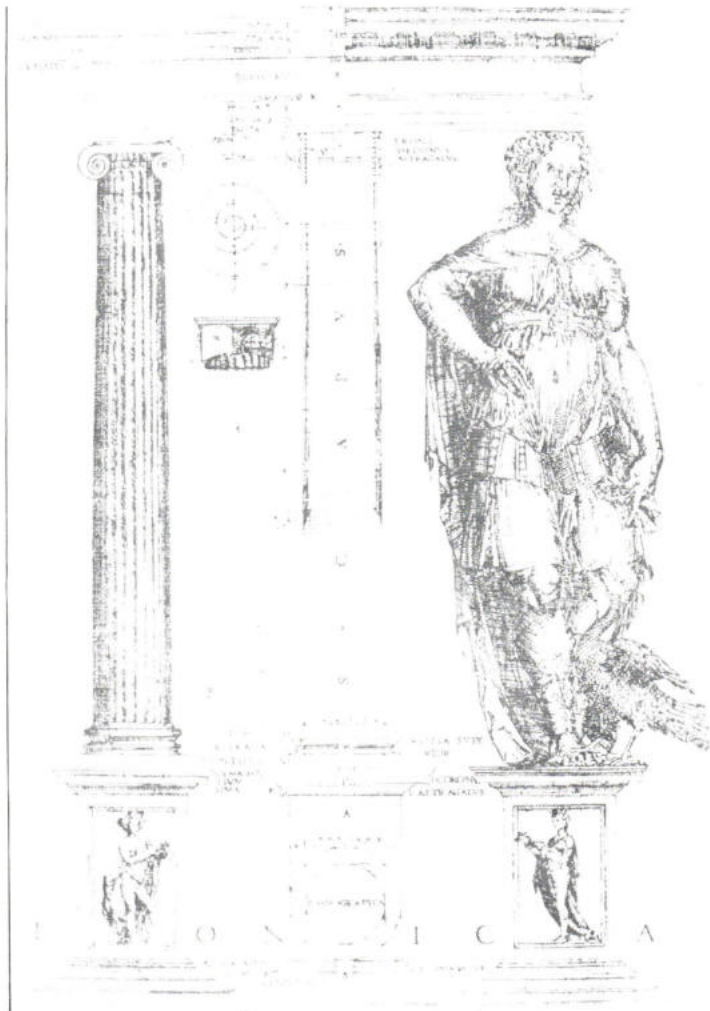

6



7

8 *Philippe de Champaigne, The Crucifixion, 1650.*

9 *The order of the temple according to Villalpanda, 1707.*

44

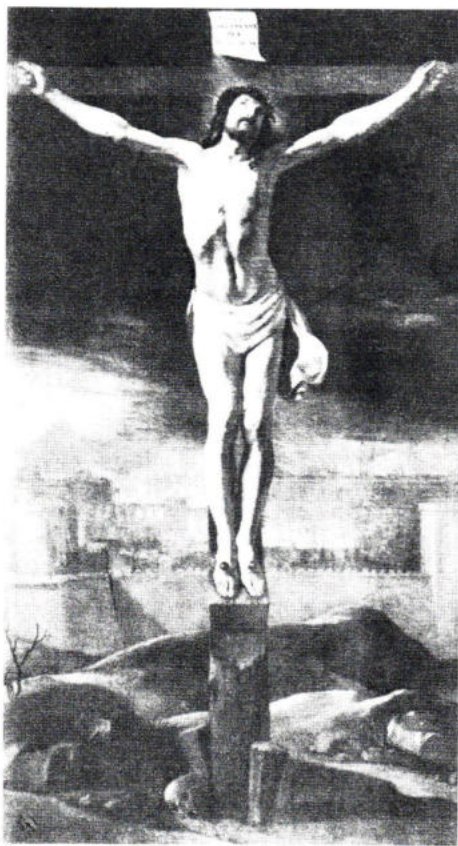

8

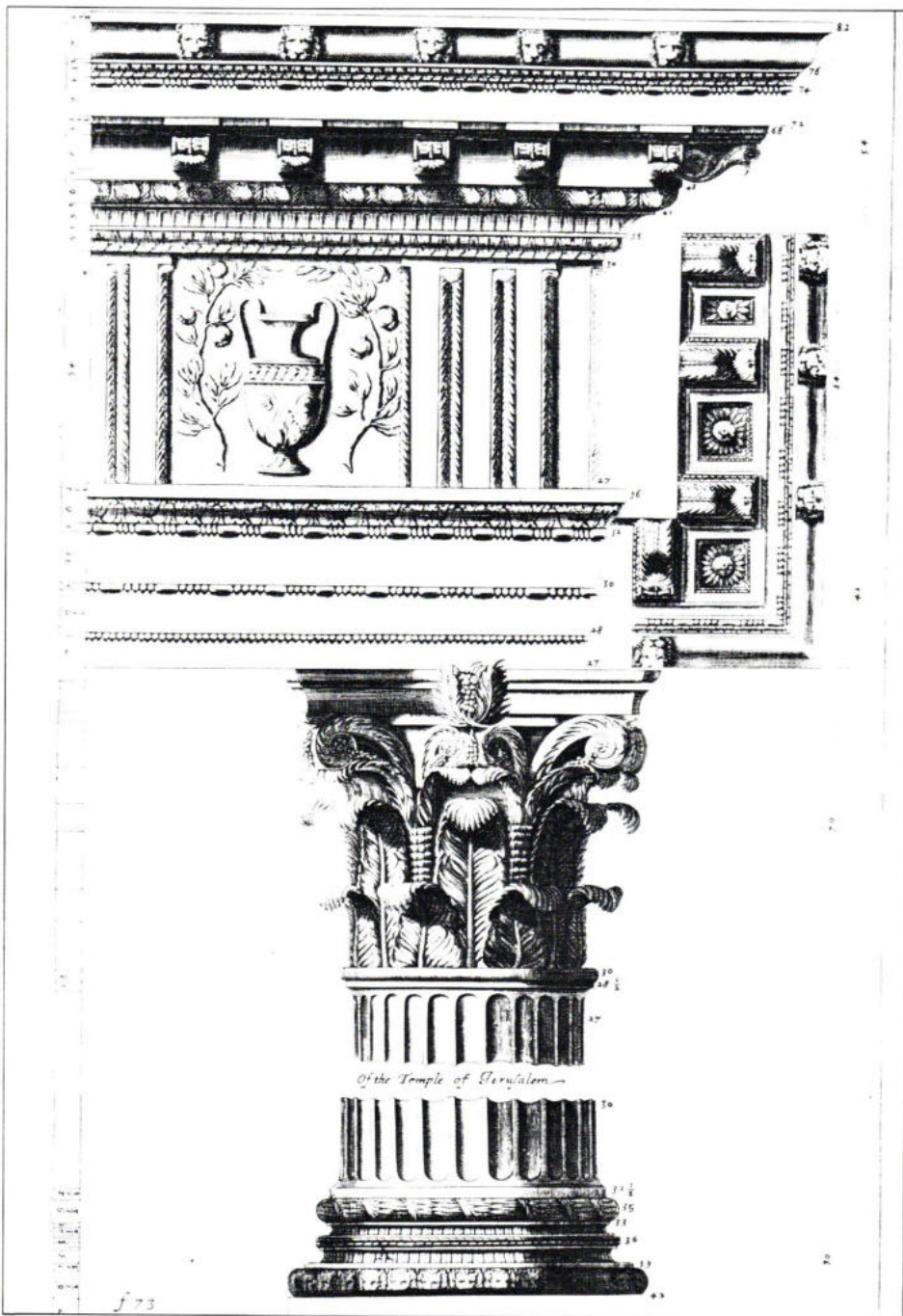

9

velopment of Roman but also of Greek and Egyptian architecture.

If one looks at Sebastiano Serlio's illustration of a tragic scene (based on a text of Vitruvius),<sup>13</sup> you will note a street flanked by "antique" palaces leading to a triumphal arch, which is also a city gate—beyond which are pyramids and obelisks (fig. 2). These *regalia res* were to serve as a background for the stories of Greek heroes as told by some of the Greek tragedians and known in translation, but especially for the Latin plays of Seneca. Nor were the pyramids and obelisks thought irrelevant to the deeds of Theseus or Oedipus.

But ever more accurate observation, and the increasing attention to the details of the ancient texts, which their circulation in printed form certainly sharpened, inevitably directed attention to certain discrepancies. Vitruvius' comments and rules did not always tally with the evidence of the ruins, for these sometimes showed techniques of construction not described by Vitruvius, such as concrete vaults and domes. But more particularly, the orders measured in the antique buildings often did not conform to the rules provided by the Roman writer.<sup>14</sup>

An order is a column-and-beam unit, regulated by a proportional rule, and garnished by a set repertory of ornament and moldings. It was regarded by the Greeks and the Romans, and later by Renaissance architects, as the touchstone and tonic of architecture, as the epitome and guarantee of architectural perfection. The repertory was very limited: Vitruvius described one Etruscan order and three Greek ones—Doric, Ionic, and Corinthian: Renaissance theorists (beginning with Serlio in 1537) added the fifth order, the Composite (fig. 4). Although many attempts were made to increase this repertory—by adding "national" orders, for instance—the five orders remained the essential elements of architectural composition from the beginning of the sixteenth to the end of the nineteenth century, and even into the twentieth.

Vitruvius had derived the proportions and the ornaments of the Doric and Ionic orders from a man's and a woman's body

respectively, and the Corinthian from that of a young girl (figs. 5–7).<sup>15</sup> This derivation was given a mystical and hermetic interpretation by some sixteenth and seventeenth-century writers. But the matter was also familiar to anyone who took an interest in architecture. When a tired and much feted Gianlorenzo Bernini arrived in Paris on 2 June 1665, where he had come—at vast expense to Louis XIV—to design the new Louvre buildings (his design was abandoned, to be replaced by Perrault's) (fig. 3), he was met outside the town by Paul Fréart, the Lord of Chantelou. After the preliminary compliments "he [Bernini] said that the beauty of everything in the world, as of architecture, consists in proportion; that you might say that it is a divine particle, since it is derived from the body of Adam, who was not only made by God's hand, but who was made in his image and likeness; that the variety of the orders of architecture proceeded from the difference between the bodies of man and of woman . . ." and writes M. de Chantelou nonchalantly in his diary, "he [Bernini] added several other things on this matter, which are familiar enough to us."<sup>16</sup>

This diary composed by Paul Fréart, one of the principal connoisseurs at the French court and Poussin's patron, was written for the author's brother Roland Fréart de Chambray, who had published one of the most popular architectural handbooks of the time some fifteen years earlier. Roland Fréart's treatise was a pattern book of the orders. But unlike those of his predecessors, it did not give one recipe for each order, but compared and criticized the various rules given by Vitruvius and more recent writers with orders found in ancient buildings and sometimes even with those used in a building by a "modern" architect, even though they had not been described in a treatise. Fréart de Chambray intended to give the architect interested in proportion a method for discriminating between the various models he might imitate, helping him to choose the most apt, the most "correct." Among these he also included the curious Corinthian "Profile" of the temple of Solomon, one that perhaps because of its exalted origins was not used very extensively, if indeed at all in any known building. It is the "flower of architecture, and the Order of Orders"<sup>17</sup>. . . Though I dare not affirm. . ." says Fréart, "[it was] to have

10 *Stonehenge restored as a Roman Temple by Inigo Jones, 1655. Projection.*

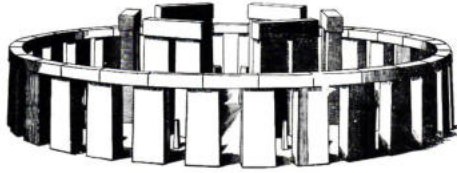

10



11



12

11 *Stonehenge, standing stones. They have altered very little since they were surveyed by Inigo Jones.*

12 *Stonehenge restored as a Roman Temple by Inigo Jones, 1655. Plan.*

been precisely the same Profile with that of Solomon's Temple . . . yet as near as one can approach to that Divine Idea from its description in the Bible and some other famous Histories mentioned in that great work of Villalpanda's . . . I conceive it to be sufficiently conformable" (fig. 9).

The work of Villalpanda to which Fréart refers is that Spanish Jesuit's three-volume commentary on the Book of the Prophet Ezekiel, in which the Prophet is granted a vision of the rebuilt temple.<sup>18</sup> Villalpanda's vast, literally massive commentary with many engravings was a justification of the divine origin of the orders, not only in the sense of the divine ordering of the human body—in the form Bernini had conversationally and quite casually described to Chantelou—but in a much more dogmatic sense; they were actually part of the divine gift of the temple "type," either drawn by the Hand of God itself, or drawn by Solomon under direct guidance from God; the proportions and ornaments of the order, as they were "seen" by Ezekiel, were identical to those of the temple Solomon built, and the Temple seen and described by Josephus Flavius<sup>19</sup> in all ways was identical to Solomon's first building. Furthermore, the orders of Architecture, as known from Vitruvius and from ancient buildings, were derived from the divine model, which united the perfections of all the orders in one. Classical architecture was therefore the only true architecture, not only because it conformed with reason—in the way the ancient authors had set out—but also because it was directly based on divine revelation.

In the atmosphere of hermetic learning and bigoted piety that pervaded the Spanish court, Villalpanda's message was comforting: the "advanced" architecture of Italy was not only a repository of ancient "gentile" wisdom, being derived ultimately from the example of the Egyptians (whose revelations included the prophecy of a Savior—hence the recurrence of Sibyls in Christian iconography), but the more "correct" it was, the nearer it came to divine revelation.

In spite of much learned objection, Villalpanda's reconstruction of the Temple was treated as the type of all splendid building; it was reproduced partially or wholly in buildings and models, in treatises and Bible illustration (fig. 8).<sup>20</sup>

For the thinkers and writers of the fifteenth and sixteenth centuries, the imitation of the Ancients had been a re-evocation of a pagan past, whose inner secrets, despite contradictory appearances, could be regarded as conforming with divine mysteries because of the natural force of the intellect, and the virtues of philosophers (Pythagoras and Plato in particular) to whom equitable Jupiter taught mysteries as valid as those which Jehovah had taught Moses.<sup>21</sup> In the more fervent and much less tolerant Counter-Reformation atmosphere (more fervent and less tolerant in Spain than elsewhere) it became a work of piety for Philip II and his Jesuit protégé. Architecture participated in the general concern with *sacrosancta vetustas* (most holy antiquity). The teaching of Vitruvius on proportion was treated throughout the Middle Ages, as well as during the Renaissance, as having the force of a revelation and as a teaching about the microcosms—a teaching which was echoed by Bernini's remarks quoted earlier. These associations allowed of little dispute. That which was drawn by the hand of God could not be derived from earthly precedent. Inevitably, other authors argued like Villalpanda, not only those who looked for divine guarantees in matters such as architecture, but all those who associated architecture with literature and ideology. Inigo Jones, for instance, some twenty years after the publication of Villalpanda's works, went to measure and reconstruct Stonehenge for King James I (who occupied the British throne with dubious legitimacy). The elaborate genealogies worked out at the time for the House of Stuart traced its descent both from David, the King of Israel, and from the mystical Brutus the Trojan, a reputed grandson or great-grandson of Aeneas, who was, according to Geoffrey of Monmouth, the founder of London, and by the antique eponymous method, gave his name to Britain.<sup>22</sup> Geoffrey of Monmouth, a twelfth-century chronicler, was the great source for the mythical prehistory of Britain. Most versions of the Arthurian legend depended on his chronicle, and it furnished material for innumerable openings of British histories, as well as for the work of the epic and tragic poets, Shakespeare's *King Lear* and Spenser's *Faerie Queen*.

Reflecting on those antiquarian fantasies, Inigo Jones restored Stonehenge as a hypaethral temple to the god Caelus

or Uranus (figs. 10–12).<sup>23</sup> Not, of course, that Inigo Jones held Stonehenge (or Stone-Heng, as he called it) to be an absolute norm for all architecture. He merely argued that a work of such technical resource and geometrical perfection could not have been produced by a barbarian people—such as the British natives described by Tacitus and Suetonius; it must, therefore, have been a work of classical civilization.

However, although the guarantee of *sacrosancta vetustas* may have seemed adequate to English seventeenth-century antiquarians, later evangelicals required firmer guarantees. So John Wood the Elder in his little guide to Stonehenge imagined the “British” King Baldud (a legendary founder of Bath, excogitated by the medieval antiquarians, Geoffrey of Monmouth in particular) as identical with the Hyperborean priests of Apollo who appear in the Delphic legend; and Baldud was thought to be privy to the theory of planetary revolution, which he imparted to the Druids who “subsisted until *Augustine* the Monk came into Britain and, by the Order of *Pope Gregory the Great*, silenced it for the same reasons that *Galileus* was condemned by the Inquisition of *Rome* in the year 1633. . . .”<sup>24</sup>

But this anti-papist stab is isolated. Wood took the opposite attitude to Inigo Jones: “the Work would appear to me as a Wonderful production of the *Roman* Art and Power, if *Britain*, in the most early Ages of the World, had not been Famed . . . for the Learning of her Natives. . . .”<sup>25</sup> He had already declared his interest and his views on architectural history in an earlier and more substantial book: *The Origin of Building: or the Plagiarism of the Heathens detected*.<sup>26</sup> This plagiarism of the heathen was the presumed derivation of ancient architecture from scriptural patterns: Noah's ark, the Ark of the Covenant in the desert, Solomon's Temple, and the vision of Ezekiel.

The very formula of Pythagoras' theorem is derived by Wood from the measurements of the ark and the age and number of animals which Abraham was ordered to offer: “Jamblichus tells,” Wood says, “that Pythagoras was twenty-two years in Egypt learning geometry . . . This was about nine hundred years after the ark was made; and therefore our present researches are intended to find out

48 the emblematical meanings of the several parts of the Tabernacle. . . .”<sup>27</sup>The relation is established by a long chain of supposition, as is the relation between the desert tabernacle and the origin of the orders.<sup>28</sup>

Again, like Villalpanda and many of his predecessors, Wood looked in scripture for a justification and a guarantee of the absolute value of mathematical proportions; this presupposition of absolute value is basic to the theories of all “classical” architecture (including the medieval speculations on the fundamental precepts of building)<sup>29</sup> and has its roots in the discovery—attributed since remote antiquity to Pythagoras—that the length of a plucked string (or for that matter of a tube or pot filled with water which is struck to produce a sound) corresponds in quantity to fixed tonal differences. A proportion of 1 : 2, for instance, will give an octave difference; 2 : 3 will give a fifth; 3 : 4 a fourth; 8 : 9 a tone, and so on.<sup>30</sup> In classical antiquity, this idea was connected with the idea of the microcosm, the proportions which govern the human body being a miniature of universal harmony. Cicero’s short essay *On the Dream of Scipio* and the commentary on it by the Latin grammarian, Macrobius, was perhaps the most familiar expression of the idea for many centuries. It also became familiar through Boethius’ and St. Augustine’s treatises on music, and it was widely reinterpreted in the Middle Ages.<sup>31</sup> The Platonic renaissance in the fifteenth and sixteenth centuries gave it enormous authority, so that it became a staple part of artists’ speculations.<sup>32</sup> In the seventeenth century the idea was given new validity. Bernini, as the quotation above from his conversation with Chantelou indicates, regarded it as a basic principle, and the orders as its most positive incarnation.<sup>33</sup> The teaching of the idea seems to have gone unquestioned by all schools. In seventeenth-century France, the idea was given a more rigorous formulation by an Oratorian priest, René Ouvrard, who had no particular architectural training, but as the master of music at the Sainte Chapelle (he had formerly been a precentor of Rouen cathedral), was a fairly well-known musician. In a book—or rather a pamphlet—on *Harmonic Architecture*,<sup>34</sup> he even reproaches the ancients for their laxity in the use of musical proportion since “we claim . . . that there is such an analogy between proportions of music and those of architecture that

what shocks the ear in one, shocks the eye in the other.”<sup>35</sup> This in itself is not remarkable: it is an echo of traditional neo-platonic teaching, as expressed, for instance, by Leone Ebreo two centuries earlier: “In the objects of all external senses there may be found good, useful, mild and delightful things, but the grace which moves the soul to particular love (which is called beauty) is not found in the objects of the three material senses, which are taste, smell, and touch, but in the objects of the two spiritual senses, sight and hearing. . . .”<sup>36</sup> Leone Ebreo, who before his conversion was known as Jehudah Abarbanel, went on to speculate on the immortal harmony inherent in material things, perceptible to the “spiritual” senses.<sup>37</sup> Starting from this background, Ouvrard studies the detailed musical implications of the orders and the types of buildings described by Vitruvius, as well as those mentioned in scripture, and their possible applications in building practice. He concludes severely: “These rules are infallible and based on the analogy of our two noble senses, in which our soul desires the same proportion . . . let them—the architects who have not given the matter enough attention—realize that this is the only means which will give their art sure and incontestable principle and that there shall be no true architecture which is not harmonic. . . .”<sup>38</sup>

Ouvrard, like so many contemporary writers on architecture, dedicated his pamphlet to Jean Baptiste Colbert, who was at that time (and was to remain until his death in 1683) Louis XIV’s superintendent—that is minister—of building as well as of finances. This position, of course, made Colbert the most powerful patron of the arts (building in particular) in France, perhaps in the world. Although Louis, in spite of a fanatical attention to detail, does not seem to have had a clearly defined taste either in literature or in the visual arts, Colbert did, and knew how to impose it discreetly—the king and the minister have been compared to Augustus and Maecenas.<sup>39</sup> The King, and Colbert as well, cared for glory more than for anything else. Glory was a guarantee of immortality; but before that, glory was an instrument of policy. It was therefore essential to enroll the arts in the service of the French crown.

The policy of the monarchy—initiated by Richelieu, and

13 *St. Anne la Royale, Paris.*  
*Guarino Guarini, architect, begun*  
*1665. Section.*

developed by Mazarin—demanded the centralizing of fiscal administration under the strictest possible state control to be used in an economically expansionist manner but also of political life, by concentrating administration as well as fashion, first on the Louvre, and then on Versailles.

Colbert's method of patronage worked by selective commissioning, and also by structuring the artistic life of the country into salary—or gratuity—receiving groups, most of which were called Academies. The words "Academy" and "Academic" were to assume such an enormous importance that it might be worth digressing shortly at this point to consider the development of the notion and the practice with which they were associated.

Academy is another word with a remote ancestry. Its ancestor "Academus" is the mythical hero who owned a garden about a mile from the Dipylon gate in Athens; it became a public garden when Cimon left it to the city. But its fame is [due to] Plato who held his school there, much as the fame of the Lycaeam, an exercise ground at the other end of town, is [due to] Aristotle. "Academy" soon came to mean the whole group of Plato's followers, and was certainly used like that by Cicero;<sup>40</sup> by whose time the group had fissured into sects. The word eventually came to be applied to the great library of Alexandria, and to bodies like Caesar Bardas' scientific group in ninth-century Constantinople. However, the first "modern" academy was founded by Alcuin of York at Charlemagne's court. The institution was perpetuated throughout the Middle Ages, though sporadically. In the fifteenth century, however, it acquired momentum; Antonio Beccadelli's Antonian or Pontanian Academy in Naples and Pomponio Leto's Academy in Rome began the trend, although the first official body of this type is Lorenzo de' Medici's Platonic Academy, which formed itself around Marsilio Ficino in the 1440s. Starting as an informal philosophical discussion group, it became a literary institute; it then broke up, and finally, in 1582, transformed itself into the Accademia della Crusca, which produced its great Italian dictionary some thirty years later.

As the century wore on, literary, scientific, and artistic societies of this kind multiplied and spread outside Italy.

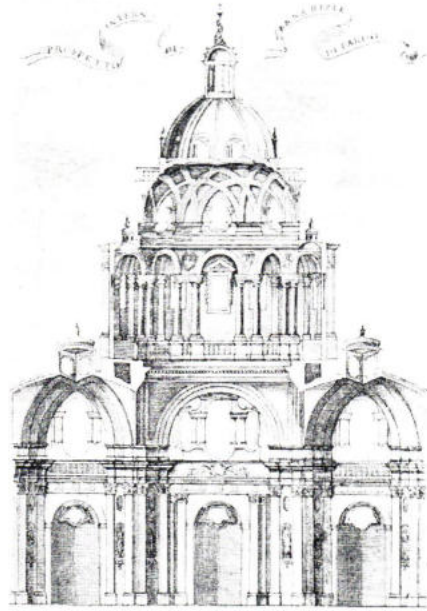

13

50 There was one or more in every town, so that by the middle of the eighteenth century there were seven hundred of them in Italy alone.<sup>41</sup> In the meanwhile, several academies of artists were started in the sixteenth century, perhaps the earliest being Giorgio Vasari's Accademia del Disegno in Florence, which was "incorporated" in 1563.<sup>42</sup> The most influential of all of them was the Bolognese academy of the Caracci, which started, rather casually, about half a century later, and where the three elements which were to become the foundation of all "academic" art school teaching—drawing from the life, drawing the antique (in the form of plaster casts), and instruction in the geometry of perspective—were already the essential subjects.

In the meanwhile, academies diversified. Scientific academies became relatively common, and in the 1620s a group of French patricians instituted the regular meetings that were incorporated as the French Academy by Louis XIII (under Richelieu's patronage) in 1635. One of its primary duties was the preparation of a "standard" dictionary of the French language, which, however, took sixty years to bring out. Under the rule of Louis XIV and Colbert, academies continued to proliferate. The French Academy required a sub-committee, the "little academy," whose purpose was to commemorate the great deeds of the King, and it later turned into the Académie des Inscriptions (at first literally inscriptions on medals, triumphal arches, etc.), as well as an Academy of Painting, of Science, and so on. The Academy of Architecture, one of the last, was founded on the death of the reigning *premier architecte du Roi*, Louis Le Vau, in 1671, and its director, the engineer-builder François Blondel, became the King's *ex-officio* advisor.<sup>43</sup>

Artists had, of course, been organized previously, chiefly into guilds which supervised apprenticeship to individual masters in their studios, accepted candidates for licenses, and regulated work conditions. But the guilds had neither the antiquarian nor the theoretical pretensions of the new academies. The Academy of Architecture, moreover, had a new task. Up to that time it was a normal part of the architect's work to undertake, as contractor, the building of what he designed. Certainly Le Vau, old Mansart, Robert Cotte, Pierre Lescot, and the other major architects from

Philibert de l'Orme onward, who were also trained as mason-masters, regarded building and contracting as part of their duties. But members of the academy were precluded from this function by their appointment, which marked, in fact, the creation of a proper professional elite. But although it was not the task of this new elite to undertake what was almost manual work, they were obliged to build up a body of theory, even of rules, for the future of architecture. In this context, René Ouvrard's pamphlet assumes a certain importance. The first director of the Academy, François Blondel, who was also its professor, was very much impressed with Ouvrard's writing and recommended his book in his lectures.<sup>44</sup>

Blondel was a mathematician by training, somewhat old-fashioned in his cast of mind. Although quite prepared to adopt a critical attitude toward the examples of the ancients, he was not prepared to flout the traditional teaching concerning the unity of the "spiritual" senses and the informing tradition of the harmonious microcosms.<sup>45</sup> In spite of opposition within the academy, Blondel's successor, Philippe La Hire, was an even more rigorous purist. The first two directors thus certainly took to heart the academy's task "to strip architecture of its vicious ornaments, to retrench the abuses which the ignorance and the presumption of workmen have introduced into it. . . ."<sup>46</sup>

There were plenty of examples of buildings that needed to be stripped and chastened in this way. The most offending, however, was the Order of the Theatine Fathers, which had, at the request of the Queen Mother Anne of Austria, commissioned their celebrated *confrère*, Guarino Guarini of Modena (who was also a distinguished mathematician), to design for them the most extravagant of Piedmontese Baroque churches, Ste. Anne-la-Royale (fig. 13), provocatively sited on the other side of the river from the main *carré* of the Louvre (now 32 Quai Voltaire). The church, as well as the scandalously opulent and theatrical acts of worship performed in it, exemplified the unwelcome Italian influence which most sections of French society rejected. The church was put up in 1665, finished (to much modified designs) almost half a century later, and totally destroyed in 1823.<sup>47</sup> Guarini, however, left a treatise as well as a consid-

14 *Philippe de Champaigne, The Last Supper, 1648.*

15 *Nicolas Poussin, The Seven Sacraments: Eucharist (The Last Supper), 1647.*

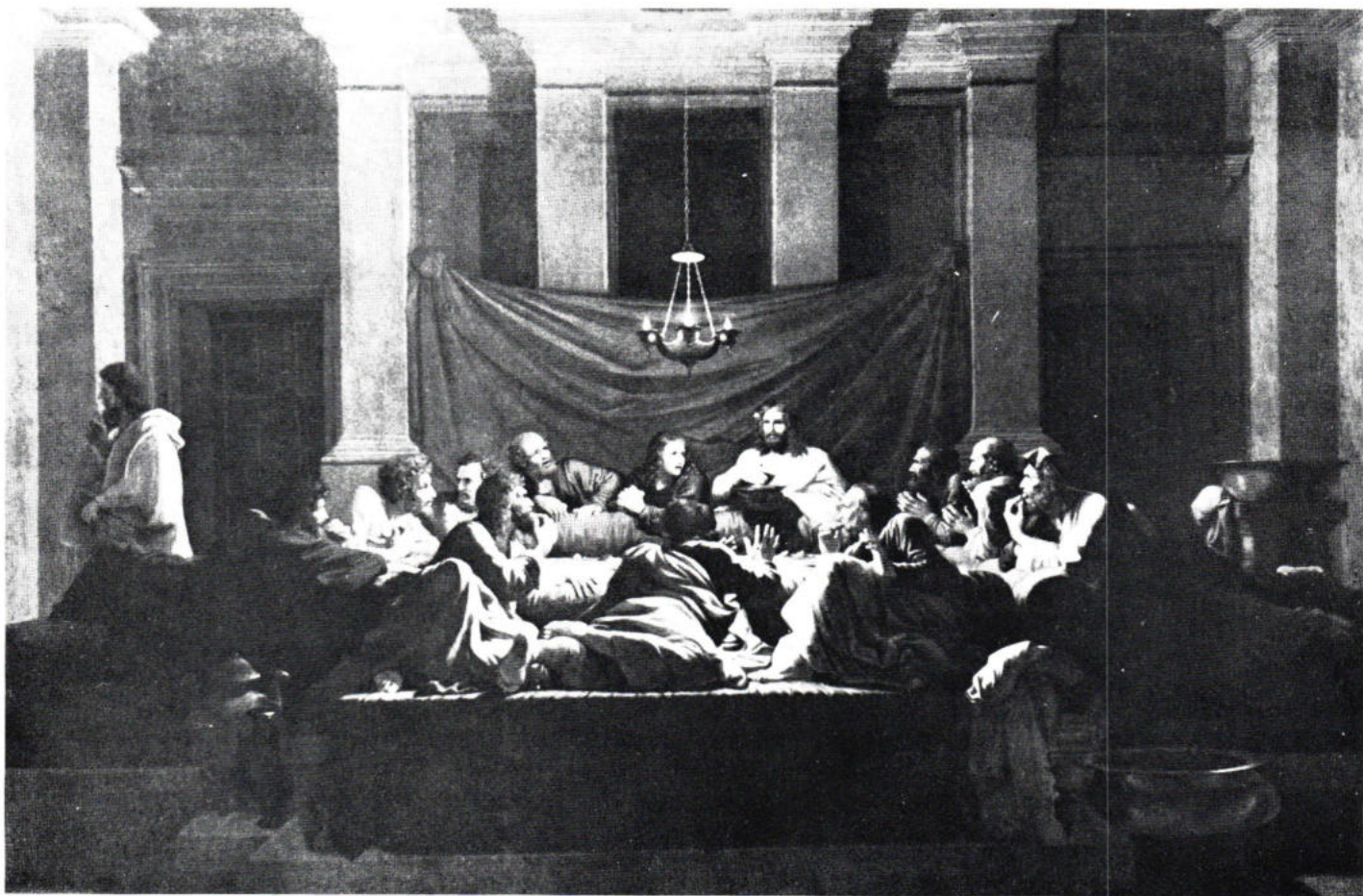

51



15

52 erable corpus of building in Turin (Palazzo Carignano, The Chapel of the Holy Shroud, San Lorenzo), which show him to have been the most *outré* follower of Borromini.

Bernini, who had no love for his great rival and Roman contemporary, would certainly have disapproved of Guarini's excessive freedom with volume, his borrowings of medieval and even Moslem forms, and the apparent capriciousness of his geometry. Certainly men like the two Fréart brothers, who were not only Bernini's admirers, but the friends and patrons of Poussin, would have found Guarini's work very distasteful.

It is, in fact, part of Fréart's purpose to castigate the excesses, both over-inventive and over-pedantic, of his contemporaries, as well as to provide an academy of architecture in a slim volume. Fréart not only disapproved of "mascaroons, wretched *Cartouches* and the like idle and impertinent *Grotesque* with which they [the slow and reptile souls who never arrive at a full knowledge of the art] have infected all our modern architecture. . . ." <sup>48</sup> but he did not care for the non-Greek orders. His book thus concentrates on the Doric, Ionic, and Corinthian orders, while making concessions to the Latin "inventions," the Tuscan, and Composite.

Fréart's argument concerned the wide, *savant* public of his time. Not only architects used his book, but sculptors and painters as well. Poussin received and read it as soon as it was published; <sup>49</sup> his fascination with the *modes* of ancient music prompted him to construct the space of a picture in terms of the orders, to harmonize with the general proportions as well as with its color scheme, so that the event represented might have a total environment. Poussin's passionately antiquarian pictures of the seven sacraments are the most obvious examples of such treatment. <sup>50</sup> His assiduous quest for the exact gesture and setting was inevitably read as another form of hermetic reference. Poussin's art corresponded perfectly to the stoic gallicanism which he shared with the Fréart brothers, and with which his most consistent Roman patron, Cassiano del Pozzo, very much sympathized. <sup>51</sup>

Compare Poussin's earnestly archeological *Last Supper* (fig. 15), which is taking place in a Tuscan triclinium, with the Upper Room in a *Last Supper* by Philippe de Champaigne (fig. 14), the self-confessed Jansenist who had been a close friend and contemporary of Poussin's. <sup>52</sup> His Upper Room is barely furnished at all: the most prominent thing in the picture is the unfolded tablecloth, whose pleats make a gridded, altar-like rectangle in the middle. It is almost as if the action of unfolding the cloth, an action which is everyday, familiar and domestic was described so graphically that any member of Champaigne's public might identify it with the spreading of the cloths on the altar for the Eucharistic celebration. This commonplace detail has, in Champaigne's admittedly weaker painting, the force of Poussin's hermetic scene-setting. <sup>53</sup> This comparison of the two pictures indicates a shift and a dissension. The sacred precedent for all the antique detail on which Poussin drew for his *Last Supper*, as Inigo Jones did for his reconstruction of Stonehenge, the detail which Villalpanda had re-validated in his great sleight-of-hand by which the orders turned out to be a Divine institution, even a Divine dictate, all that was anatomized and reduced in the double solvent of Cartesian analysis and of the Jansenist conviction that the will, in whose realm taste operated, was irredeemably corrupt. Antiquity therefore was to become a mere repertory of detail. But to Poussin and to Blondel, and Jones, and to generations before them, antiquity was much more than that: it was the source of a method which was enshrined in the touchstone of the orders through which the harmony of the noble senses, of sight and sound, was guaranteed, as the orders, by Villalpanda's leap of an *interpretatio Christiana* keyed the architects' and artists' practice and speculation into revealed truth. It was timeless teaching which provided a rule, but was also validated by the great precedent: golden past. Antique greatness and Holy Writ were its two guarantors, and with their help all significant remains from the past—such as Stonehenge—must be interpreted. It was a teaching, too, whose unchangeable ordonnance allowed the greatest range of sober variety within the hoary tradition.

1. J. W. Goethe, *Gedankausgabe*, vol. XXIV, p. 332 (conversation with J. P. Eckermann), and later, on the way Hugo's great talent was spoiled by 'romanticism', pp. 759 f.
2. On the meaninglessness of the term "romantic," see Arthur O. Lovejoy, "The Meaning of Romanticism for the Historian of Ideas" *Journal of the History of Ideas*, II (1941), p. 261; see however, René Welleck, *The Concepts of Criticism*, ed. Stephen G. Nichols Jr. (New Haven and London, 1963), pp. 128 ff.
3. Livy I. 43. cf. Ennius, *Annals* fr. 18 and Aul. Gellius, *Noct. Att.* XVI, 10. For an early use of *proletarius* to mean "common," "clumsily said." See Plautus, *Miles Glor.* III, 157.
4. M. T. Varro, *de Lingua Latina*, V, 91. J. du Cange, *Glossarium*, s.v. *classicus*, *classicum*.
5. So Aulus Gellius, XVIII, 10, quoting M. Cato.
6. *Classicus assiduusque aliquis scriptor non proletarius*, Aulus Gellius, *Noctes Att.* XI, 8.
7. Antonio Segni and Orazio Ricasoli Rucellai are usually quoted in this context.
8. Sir E. Sandys, *Europae Speculum* (London, 1599), NED sv *Classic*.
9. *The Times*, 6 May 1893, p. 17, col. 2. The painting *The Sleep of the Gods* by Arthur Hacker (ARA, 1894) was described in the course of a notice of the 1893 Royal Academy show. The term "neo-classical" was also used, interchangeably with neo-Hellenic.
10. S. Giedion, *Spätbarocker und Romantischer Klassizismus* (Munich, 1922), p. 11 ff.
11. L. Pastor, *History of the Popes* (London, 1906), vol. 1., pp. 18 f.
12. Edgar W. Anthony, *Early Florentine Architecture and Decoration* (Cambridge, Mass., 1927), pp. 77 ff.
13. Vitruvius, V, 6, ix.
14. What is more, one order found in ancient buildings, in the Colosseum for instance, and later described as "composite," is not described at all by Vitruvius.
15. Vitruvius, IV, 1; IV, 7.
16. Paul Fréart, Sieur de Chantelou, *Journal du Voyage en France du Cavalier Bernin* (Paris, 1930), p. 20.
17. *A Parallel of the Ancient Architecture with the Modern . . . written in French by Roland Fréart, Sieur de Chambray . . . Made English for the Benefit of Builders by John Evelyn, Esq.*, (London, 1723), p. 76.
18. Ezekiel 40-44, 3. Jeronimo Prado and Juan Bautista Villalpanda, *In Ezechielem Explanaciones* (Rome, 1596-1602).
19. J. Flavius, *Jewish Antiquities*, VIII, 2; XI, 4.
20. René Taylor, "Architecture and Magic: Considerations on the Idea of the Escorial," pp. 81 ff; W. Hermann, "Unknown Designs for the Temple of Jerusalem by Claude Perrault," pp. 143 ff.; *Essays in the History of Architecture presented to Rudolf Wittkower*, Douglas Fraser, Howard Hibbard, and Milton J. Lewine, eds. (New York: Phaidon Publishers, Inc., 1967).
21. E. Panofsky, *Renaissance and Renascence in Western Art* (Stockholm, 1960), pp. 178 ff.; cf. E. Cassirer, *Individuo e Cosmo nella Filosofia del Rinascimento* (Florence, 1935), pp. 12, 117 f.
22. Cf. Michael Drayton, *Poly-Olbion*, Book I, lines 304 ff., and comment on line 312. A very popular versified version of Goefrey's account is given in Thomas Heywood's *Troia Britannica or Great Britaine's Troy* (London, 1609), the sixteenth canto, pp. 413 ff.
23. *The Most notable Antiquity of Great Britain, vulgarly called Stone-Heng . . . restored by Inigo Jones, Esq. . . . to which are added Chorea Gigantium, or Stone-Heng restored to the Danes by Dr. Charleton and Mr. Webb's vindication of Stone-Heng restored . . .* (London, 1725), pp. 59 ff.
24. *Choirquare, vulgarly called Stonehenge . . .* by John Wood, Architect (Oxford, 1747), p. 22.
25. *Ibid.*, p. 68.
26. By John Wood, Architect (Bath, 1741).
27. *Ibid.*, p. 71.
28. *Ibid.*, p. 76.
29. On the medieval speculations, see for instance Otto von Simson, *The Gothic Cathedral* (London, 1956), pp. 21 ff, or P. Frankl & E. Panofsky, "The Secret of the Medieval Masons," *Art Bulletin*.
30. See collection of texts in R. Wittkower, *Architectural Principles in the Age of Humanism* (London, 1949).
31. O. von Simson, *The Gothic Cathedral* (London, 1956), pp. 25 ff.
32. Cf. Wittkower, *Architectural Principles*.
33. *Ibid.*
34. René Ouyard, *Architecture harmonique ou application de la doctrine des proportions de la musique à l'architecture* (Paris, 1677).
35. *Ibid.*, p. 4.
36. Leone Ebreo, *Dialoghi d'Amore*, S. Caramella, ed. (Bari, 1929), p. 226.
37. *Ibid.*, pp. 227, 317 ff.
38. Ouyard, *Architecture Harmonique*, p. 30.
39. Antoine Adam, *Histoire de la littérature française au XVII siècle* (Paris, 1952), vol. II, p. 9.
40. De oratore III, 18 ff. cf. N. Pevsner, *Academies of Art, Past and Present* (Cambridge 1940), pp. 1 ff.
41. J. Jarkius, *Specimen Historiae Academicarum Eruditarum Italiae* (Leipzig, 1729), passim.
42. N. Pevsner, *Academies of Art* (Cambridge, 1940), pp. 95, 296.
43. L. Hauteceur, *Histoire de l'architecture classique en France*, II (1), pp. 462 ff; cf. B. Teyssède, *L'art au siècle de Louis XIV*, pp. 77 ff.
44. François Blondel, *Cours d'architecture à l'académie royal de l'architecture* (Paris, 1698), ii, p. 756.
45. *Ibid.*, p. 250. F. Blondel's opening speech to the Academy, in H. Lemonnier, *Procès-Verbaux de l'Académie d'Architecture Paris, 1911-1929*.
46. Hauteceur, *Histoire de l'architecture classique en France*, Vol II (i), p. 465.
47. J. F. Blondel, *L'architecture française*; R. Wittkower, *Art and Architecture in Italy 1600-1750* (Hammondsworth, 1958), p. 269.
48. Fréart de Chambray, *A Parallel of the Ancient Architecture*.
49. He writes to Fréart de Chantelou about it on the 29 August 1650; Fréart de Chambray had spoken of Poussin in the most flattering terms in his introductory *Epistle*.
50. There are two sets; the first, painted for Cassiano del Pozzo is now at Belvoir Castle (except for the *Baptism* at Washington). The second, painted some years later for Fréart de Chantelou, is in the National Gallery of Scotland. On the two sets see A. Blunt,

- 54 *Poussin* (London, 1967), vol. I, pp. 186 ff. There is a related painting of the *Institution of the Eucharist*, painted for Louis XIII, to be placed over the high altar at St. Germain, and now in the Louvre: *ibid.*, p. 189, n. 48.
51. On Cassiano del Pozzo, see F. Haskell, *Patrons and Painters* (London, 1963), pp. 98 ff. On Poussin's religious opinions, see A. Blunt, *Poussin*, vol. I, pp. 177 ff., and more recently, H. Hibbard, *Poussin: The Holy Family on the Steps* (London, 1974), pp. 43 ff.
52. They had shared a room when they were both young, in Paris. Philippe de Champaigne had been close to Port-Royal long before his daughter, Catherine, became a nun there. He had done a portrait of Cornelius Jansens, but it was probably a posthumous one, which was engraved by Morin. *The Last Supper* was painted as an altarpiece for Port-Royal and is now in the Louvre.
53. Philippe de Champaigne was very much aware of the contrast, as is apparent from his strictures on Poussin's antiquarian 'slavery' in his lecture to the Academy of Painting. *Procès-Verbaux de l'Académie Royale*. . . ed. Anatole de Montaiglon (Paris, 1875-1909), vol. III, pp. 127 ff.

#### Figure Credits

- 1, 3, 5-7, 11 Courtesy the author.  
2 Courtesy Anthony Vidler.  
4 Sebastiano Serlio, *Architettura di Sebastiano Serlio Bolognese* (Venice, Italy: Combi & La Nou, 1663), p. 235.  
8, 14 Mabile de Poncheville, *Philippe de Champaigne* (Paris: Plon Publishers, 1938).  
9 *A Parallel of Architecture both Ancient and Moderne by Roland Fréart de Chambray* (Farnborough, Hampshire: Gregg International Publications, 1970), plate 73.  
10, 12 Inigo Jones, *The Most Notable Antiquity of Great Britain vulgarly called Stonehenge* (Yorkshire and London: Scolar Press Ltd., 1972).  
13 Guarino Guarini, *Trattati di Architettura, a Cura di Renato Bonelli e Paolo Portoghesi*, vol. 8 (Milan: Edizioni il Poligilo, 1968), plate 11.  
15 Anthony Blunt, *Poussin* (Bollingen Foundation, distributed by Pantheon Books, 1967), plate 159.

Bernard Tschumi

The white crusade of modern architecture, which dreamed of a healthy society running free through verdant parks, basking under an eternal sun, and serviced to its last desire by the transparent machines of its buildings, was rooted in the therapeutic ideology of the nineteenth century. The first models of a functional architecture were developed in the design of hospitals—"healing machines" as the late eighteenth century called them—and the premises of reform urbanism were based on the pathology of slum conditions initially diagnosed by doctors.

The white interiors of asylums and hospitals, first conceived as environments for inducing calm (by removing sensory stimuli) and returning the mind to its original *tabula rasa*, were, with the Modern Movement, made general to all architecture. Ornament, already "detached" from the geometrically pure "bones" of structure by historicist eclecticism, was finally suppressed on behalf of cleanliness, machine-made surfaces, and simple economy. In this way modern architecture defined its life against the consciousness of death and decay introduced by modern physiology.

The fight against ornament was informed by another—but ultimately complementary—fear: that of art, seen on one level as a profoundly revolutionary and psychologically unsettling practice. Adolf Loos, in his celebrated dictum, "the work of Art

is revolutionary, the house conservative," separated out the craft of architecture (a commonsense response to the everyday needs of life) from the art of painting (a deeply shattering exploration of the psyche as embodied in the paintings of his friend Kokoshka). As Carl Schorske has pointed out, it was Loos' aim to provide the quiet wall on which to hang such a painting. The disturbing effects of art, linked to the erotic and play impulses, although seized upon by the Surrealists, were until recently generally eschewed by architects more concerned to develop "machines for living in" than art to wrestle with. The positivistic utopia of modern architecture was in this way based on the repression of death, decay, and the "pleasure principle."

In this brief but evocative essay, Bernard Tschumi opens the question of the forbidden territories that lie beyond the limits of the mechanically therapeutic vision. He shows the connection between these limits and the taboo of death in modern middle class society. In the machine age the perception of the life and death of objects is hidden beneath the myth of their eternal life—ready disposability removes the decay of the object from sight. Transgressing these boundaries, Tschumi proposes that the philosophical position of Georges Bataille, concerned to reveal the underworld of thought—from eroticism to putrefaction—illuminates and perhaps overcomes the "false" dialectic of natural phenomena imposed by rational thought since the

Enlightenment.

The question of the *art* of architecture, closed by the functional ethic, may well be opened, with all its disturbing implications, by this attempt in the domain of *ideas*. But one wonders whether the simple "liberation" of scatological thought will in the end provide the armature for a fundamental critique; or whether another utopia is not now in the making, this time in the soft ground of a Swiftian phenomenology beneath the ruins of bourgeois mores. AV

Bernard Tschumi was born in 1944, lived in Paris until 1954, and studied architecture in Zurich before joining the Architectural Association faculty in London in 1970. He organized, with Roselee Goldberg, the exhibition "A Space: A Thousand Words" for the Royal College of Art, London, in 1975. He has also taught at The Institute for Architecture and Urban Studies, New York, and is presently teaching at Princeton University. As part of his present research he is writing a series of articles: "The Pyramid and the Labyrinth" (*Studio International*); "The Garden of Don Juan" (*L'Architecture d'Aujourd'hui*); and "The Pleasure of Architecture" (*Architectural Design*). His recent projects include "La Casa Castrata" and "Don Juan in Central Park."

**The most architectural thing  
about this building is  
the state of decay in which it is.**

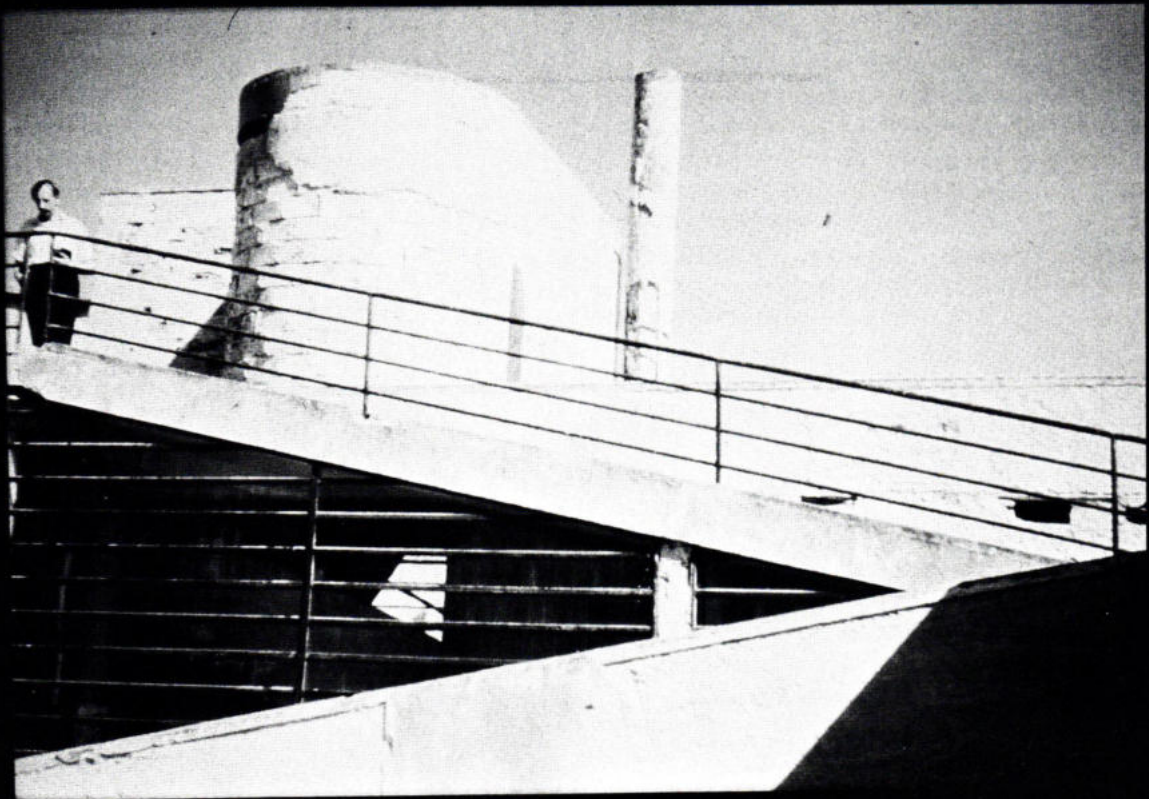

VILLA SAVOYE, 1965

Architecture only survives where it negates  
the form that society expects of it.  
Where it negates itself by transgressing  
the limits that history has set for it.

*Transgression opens the door into what lies beyond the limits usually observed, but it maintains these limits just the same. Transgression is complementary to the profane world, exceeding its limits but not destroying it.*

Georges Bataille, *Eroticism*

One issue rarely raised in architecture is that of taboo and transgression. Although society secretly delights in crime, excesses, and violated prohibitions of all sorts, there seems to be a certain puritanism among architectural theorists. They easily argue about rules, but rarely debate their transgression. From Vitruvius to Quatremère de Quincy, from Durand to Modern Movement writers, architectural theory is primarily the elaboration of rules, whether based on an analysis of historical tradition or on a New Man (as the twenties' architects conceived it). From the "Système des Beaux-Arts" to "computer-aided design," from functionalism to typologies, from the accepted rules to the invented ones, there is a comprehensive and ever-present network of protective precepts. However, my purpose here is not to criticize the notion of rules, nor to propose new ones. On the contrary, the present article will attempt to demonstrate that transgression is a whole, of which architectural rules are merely one part.

Before speaking about transgression, however, it is first necessary to recall the paradoxical relationship between architecture as a product of the mind, as a conceptual and dematerialized discipline, and architecture as the sensual experience of space and as a spatial praxis.

### **Part One: The Paradox of Architecture**

*If one has a passion for the absolute that cannot be healed, there is no other way out than to constantly contradict oneself and to reconcile opposite extremes.*

Frederic Schlegel, quoted by Novalis in *Blütenstaub*

The very fact that something is written here makes it part of the field of architectural representation. Whether I use words, plans, or pictures, each page of this publication could be likened to the mythological world of Death: that is, it benefits from the privilege of extra-territoriality; it is outside architecture; it is outside the reality of space.

Words and plans are safeguarded among mental constructs. They are removed from real life, subjectivity, and sensuality. Even when the words of the printed page are metamorphosed into slogans sprayed on city walls, they are nothing but a discourse. Boullée's aphorism that "the production of the mind is what constitutes architecture" merely underlines the importance of conceptual aims in architecture, but it excludes the sensual reality of spatial experience altogether.

A debate at a recent Conceptual Architecture conference in London<sup>1</sup> (where the majority of contributors predictably concluded that "all architecture is conceptual") emphasized the strange paradox that seems to haunt architecture: namely, the impossibility of simultaneously questioning the nature of space and, at the same time, making or experiencing a real space. The controversy indirectly reflected the prevalent architectural attitudes of the past decade. If the political implications of the production of building had been abundantly emphasized in the years following the 1968 crisis, the subsequent Hegelian reaction was revealing: "architecture is whatever in a building does not point to utility,"<sup>2</sup> and of course, by extension, whatever cannot be the mere three-dimensional projection of ruling socio-economic structures, as theorists of urban politics were then maintaining. This emphasis on what Hegel called the "artistic supplement added to the simple building"—that is, on the immaterial quality that made it "architectural"—was no return to the old dichotomy between technology and cultural values. On the contrary, it set an ambiguous precedent for those "radical" architects who did not regard the constructed building as the sole and inevitable aim of their activity. Initially intended as an ideological means of stressing architectural "avant-garde attitudes" and refusing capitalist constraints, the work of such "radical" Italian or Austrian groups of the late sixties was an attempt to dematerialize architecture into the realm of concepts.<sup>3</sup> The subsequent statement "everything is architecture" had more affinities with conceptual art than with all-inclusive eclecticism. But if everything was architecture, by virtue of the architect's decision, what distinguished architecture from any other human activity?

58 Structural linguistic studies developed in the sixties in France and Italy conveniently suggested a possible answer: analogies with language appeared everywhere, some useful, some particularly misleading. The chief characteristic of these analogies was their insistence on concepts. Whether these theorists stated that architecture always represented something other than itself—the idea of God, the power of institutions, etc.—or whether they took issue with the interpretation of architecture as a (linguistic) product of social determinants (and thus insisted on the autonomy of an architecture that only referred to itself, to its own language and history), their discourse reintroduced *rules* that were to govern architectural work by making use of old concepts such as types and models.<sup>4</sup>

This constant questioning in the last decade about the nature of architecture only underlined the inevitable split between discourse and the domain of daily experience:<sup>5</sup> . . . *Yes, space is real, for it seems to affect my senses long before my reason. The materiality of my body apparently coincides with the materiality of space. My body carries spatial properties and spatial determination: up, down, right, left, symmetry, asymmetry. In the midst of fragmenting suburban redevelopments, my subjectivity is trying to rediscover its lost unity. . . .*<sup>6</sup>

The architectural paradox had intruded once more. By definition architectural concepts were absent from the experience of space. Again, *it was impossible to question the nature of space* and at the same time make or experience a real space. One could not experience and at the same time think one experienced; “the concept of dog does not bark,” the concept of space is not in a space, ideal space is not real space.

While “ideal space” ambiguously referred to the product of mental processes and to the Hegelian “artistic supplement,” “real space” referred to the product of social praxis and to the immediacy of a spatial sensation. Such a complex opposition between ideal and real space was certainly not ideologically neutral, and the paradox it implied was fundamental.

Caught, then, between sensuality and a search for rigor,

between a perverse taste for seduction and a quest for the absolute, architecture seemed to be defined by the questions it raised. *Was architecture really made of two terms that were interdependent but mutually exclusive?* Did architecture constitute the reality of subjective experience while this reality got in the way of the overall concept? Or did architecture constitute the abstract language of absolute truth while this very language got in the way of feeling? Was architecture thus always the expression of a lack, of a shortcoming, or something incomplete? And if so, did architecture always necessarily miss either the reality or the concept? Was the only alternative to the paradox silence, a final nihilistic statement which would provide modern architectural history with its ultimate punchline, its self-annihilation?<sup>7</sup>

Such questions are not rhetorical. It may be tempting to answer “yes” to all of them and accept the paralyzing consequences of a paradox which recalls philosophical battles of the past—Descartes versus Hume, Spinoza versus Nietzsche, Rationalists versus Raumempfindung symbolists. It is even more tempting, however, to suggest another way around this paradox, to refute the silence the paradox seems to imply, even if this alternative proves intolerable.

## Part Two: eROTicism

*It appears that there is a certain point in the mind wherefrom life and death, reality and imaginary, past and future, the communicable and the incommunicable cease to be perceived in a contradictory way.*

André Breton, *The Second Manifesto*

Paradoxes equivocate. They lie, and they don't, they tell the truth, and they don't. Each meaning has always to be taken with the others. The experience of the liar paradox is like standing between two mirrors, its meanings infinitely reflected. The paradox is literally speculative.<sup>8</sup> To explore it, it is useful to consider two correspondences without which much remains obscure.<sup>9</sup>

### *First correspondence*

The first correspondence is obvious and immediate. It is the

correspondence of eroticism. Not to be confused with sensuality, eroticism does not simply mean the pleasure of the senses. Sensuality is as different from eroticism as a simple spatial perception is different from architecture. "Eroticism is not the excess of pleasure, but the pleasure of excess": this popular definition mirrors our argument. Just as the sensual experience of space does not make architecture, the pure pleasure of the senses does not constitute eroticism. On the contrary, "the pleasure of excess" requires consciousness as well as voluptuousness. Just as eroticism means a double pleasure that involves both mental constructs and sensuality, the resolution of the architectural paradox calls for architectural concepts and at the same instant the immediate experience of space. Architecture has the same status, the same function, and the same meaning as eroticism. At the possible/impossible junction of concepts and experience, architecture appears as the image of two worlds: personal and universal. Eroticism is no different; for one whose concept leads to pleasure (excess), eroticism is "personal" by nature. And by nature it is also "universal." Thus, on the one hand, there is sensual pleasure, the other and the I; on the other hand, historical inquiry and ultimate rationality. Architecture is the ultimate erotic "object," because an architectural act, brought to the level of excess, is the only way to reveal both the traces of history and its own immediate experiential truth.<sup>10</sup>

### *Second correspondence*

The junction between ideal space and real space is seen differently in the second correspondence. This second correspondence is immensely general and inevitably contains the present argument as it would contain many others. It is nothing less than the analogy of life-and-death, applied here to one celebrated architectural example.

Each society expects architecture to reflect its ideals and domesticate its deeper fears. And architecture and its theorists rarely negate the form that the society expects of it. Loos' celebrated attack on the intrinsic criminality of ornament was echoed by the Modern Movement's admiration for engineering "purity," and its admiration was translated into architectural terms by an unconscious consensus. "The engineers fabricate the tools of their time—

everything except moth-eaten boudoirs and moldy houses. . . ." <sup>11</sup> This consistent repudiation of the so-called "obscene scrawl" <sup>12</sup> (as opposed to the puritan sense of hygiene) is not unlike mankind's horror for decaying and putrefied bodies. Death is tolerated only when the bones are white: if architects cannot succeed in their quest for "healthy and virile, active and useful, ethical and happy" <sup>13</sup> people and houses, they can at least be comfortable in front of the white ruins of the Parthenon. Young life and decent death, such was the architectural order.

Calling itself "modern" as well as independent of the "bourgeois" rules of the time, the heroic tradition of the thirties nevertheless reflected the deep and unconscious fears of society. Life was seen as a negation of death—it condemned death and even excluded it—a negation which went beyond the idea of death itself and extended to the rot of the putrefying flesh. The anguish about death, however, only related to the phase of decomposition, for white bones did not possess the intolerable aspect of corrupted flesh. Architecture reflected these deep feelings: putrefying buildings were seen as unacceptable, but dry white ruins afforded decency and respectability. From being respectful to seeking respectability, there is only one step. Are the rationalists or the New York "Five" today unconsciously striving for respect through the white and timeless skeletons they propose?

Moreover, the fear of decaying organisms—as opposed to the nostalgic search for the "outmoded purity of architecture"—appears in conservationist enterprises as much as in utopian projects. Those who in 1965 visited the then derelict Villa Savoye certainly remember the squalid walls of the small service rooms on the ground floor, stinking of urine, smeared with excrement, and covered with obscene graffiti. Not surprisingly, the long campaign to save the threatened "purity" of the Villa Savoye doubled in intensity in the months that followed, and finally succeeded.

Society scares easily at those aspects of sensuality that it qualifies as obscene. "*Inter faeces et urinam nascimus*" ("we are born between excrement and urine"), wrote St. Augustin. In fact, the connection between death, fecal mat-

60 ter, and menstrual blood has often been demonstrated. In his studies of eroticism, Le Corbusier's contemporary, Georges Bataille,<sup>14</sup> pointed out that the fundamental prohibitions of mankind were centered on two radically opposed domains: death and its obverse, sexual reproduction. As a result, any discourse about life, death, and putrefaction implicitly contained a discourse on sex. Bataille claimed that at the key moment when life moved toward death, there could no longer be reproduction, but only sex. Since eroticism implied sex without reproduction, the movement from life to death was erotic; "eroticism is assenting to life up to the point of death," wrote Bataille.

Just as Bataille's approach was certainly not exempt from the social taboos of his time, similar taboos surrounded many of the Modern Movement's attitudes. The Modern Movement loved both life and death, but separately. Architects generally do not love that part of life that resembles death: decaying constructions—the dissolving traces that time leaves on buildings—are incompatible with both the ideology of modernity and with what might be called conceptual esthetics. But in the opinion of this author—which is admittedly subjective—the Villa Savoye was never so moving as when plaster fell off its concrete blocks. While the puritanism of the Modern Movement and its followers has often been pointed out, its refusal to recognize the passing of time has rarely been noticed. (Not surprisingly, glass and glazed tiles have been among the preferred materials of the movement—for they do not reveal the traces of time.)

But to pursue this "distasteful" demonstration to the logical point where the distinction between argument and metaphor becomes blurred, it is my contention that the *moment of architecture* is that moment when architecture is life and death at the same time, when the experience of space becomes its own concept. In the paradox of architecture, the contradiction between architectural concept and sensual experience of space resolves itself at one point of tangency: *the rotten point*, the very point that taboos and culture have always rejected. This metaphorical rot is where architecture lies. Rot bridges sensory pleasure and reason.

### Part Three: The Transgression

*Living in conformity with the archetypes amounted to respecting the 'law' . . . through the repetition of paradigmatic gestures, archaic man succeeded in annulling time.*

*Mircea Eliade, Cosmos and History*

*I was subject to respecting too much in my youth.*  
*Stendhal, Souvenirs d'egotisme.*

It is tempting to leave the argument here and let the reader determine for himself where this metaphorical "rot" becomes architecture and where architecture becomes erotic. For like eroticism, the phenomenon described here is of universal nature, although the suggested attitudes are subjective and particular. However, it is important to underline exactly what the two correspondences imply.

First, the two correspondences—that of rot and that of life and death—are aspects of the same phenomenon. In both cases, the meeting point of ideal and real space is a proscribed place; just as it is "forbidden" to experience pleasure while thinking about it, it is forbidden to look at the place where life touches death: Orpheus is not allowed to watch Eurydice's passage from death to life.

The life-and-death correspondence materializes the meeting place: the meeting place becomes the "memory" of life between death, the "rotten" place where spatial praxis meets mental constructs, the convergence of two interdependent but mutually exclusive aspects.

Second, and very literally, such a place may possess the moldy traces that time leaves on built form, the soiled remnants of everyday life, the inscriptions of man or of the elements—all, in fact, that *marks* a building.

Third, by extension, this meeting place is a threat to the autonomy of, and the distinction between, concepts and spatial praxis. We have seen the Beaux-Arts architects at the turn of the century display blindness toward pure engineering structures, and most contemporary architects close their eyes to the traces of decay. Of course, the taboos

that haunt architects are hardly surprising. Most architects work from paradigms acquired through education and through subsequent exposure to architectural literature, often without knowing what characteristics have given these paradigms the status of rules or, by inversion, that such paradigms imply subsequent taboos. These paradigms-taboos may be more binding and more complex than any set of rules that might be abstracted from them; they remain entrenched because of the difficulty in unveiling the hidden rules that have guided the particular architectural approaches that generated them. Rules stay obscured, for schools of architecture never teach concepts or theories in the abstract. As a result, architects' perceptions are often as culturally conditioned as those of a school child, even if the nature of this conditioning changes throughout history.

Fourth, by a further extension, the meeting place is ultimately architecture. It thrives on its ambiguous location between cultural autonomy and commitment, between contemplation and habit. In fact, if a piece of architecture renounces its conceptual autonomy by recognizing its latent dependency on reality—social or economic—it accepts its integration into the restrictive mechanisms of society. On the other hand, it sanctuarizes itself in an art for art's sake position; it does not escape classification among existing ideological compartments. So architecture seems to survive in its "erotic" capacity only wherever it *negates* itself, where it transcends its paradoxical nature by negating the form that society expects of it. In other words, it is not a matter of destruction or "avant-garde" subversion, but of *transgression*.

While recently the rules called for the rejection of "ornament," today's sensibility has changed and purity is under attack. In a similar way, while the crowded street of the turn of the century was criticized by CIAM's theories of urban fragmentation, today the ruling status of the social and conceptual mechanisms eroding urban life is already the next to be transgressed.

Whether through literal or "phenomenal" transgression, architecture is seen here as the momentary and sacrilegious

convergence of real space and ideal space. Limits remain, 61  
for transgression does not mean the methodical destruction of any code or rule that concerns space or architecture. On the contrary, it introduces new articulations between inside and outside, between concept and experience. Very simply it means overcoming unacceptable prevalences.

1. London, 1975. With Peter Eisenman, Roselee Goldberg, Peter Cook, Colin Rowe, J. Stezaker, Bernard Tschumi, Cedric Price, W. Alsop, Charles Jencks, Joseph Rykwert, etc.

2. Cf. Hegel, *The Philosophy of Fine Art*, Vol. I (London: 1928). Is the architectural discourse a discourse about whatever does *not* relate to “building” itself? Hegel concluded in the affirmative: architecture is whatever does not point to utility. Hegel’s conclusion seems to find a belated echo among those who have recently rediscovered the notion of architectural autonomy.

3. It seems superfluous to document in detail the numerous contributions that have appeared under the generic title of “Radical Architecture” and which were included in “The New Italian Landscape” exhibition at The Museum of Modern Art in New York, 1972. See also various magazines such as *Casabella*, *Architectural Design*, etc., for their documentation of the work of Superstudio, Archizoom, Hans Hollein, Walter Pichler, Raimund Abraham, etc.

4. Cf. *Architettura Razionale*, Franco Angeli, ed. (Milan: 1973), and the publications that followed the XV Milan Triennale organized by Aldo Rossi. See also Manfredo Tafuri’s critique of the claim that architecture is an endless manipulation of the grammar and the syntax of the architectural sign (*Oppositions 3*). Freed from reality, apparently independent of ideology, architectural values seem to strive toward a “purity” that recalls the Russian formalist criticism of the twenties, when it was argued that the only valid object of literary criticism was the literary text.

5. Cf. *A Space: A Thousand Words* (London: RCA Gallery, 1975); *The Chronicle of Space*, documenting student work done in the Diploma School of the Architectural Association, London, from 1974–1975; the “Real Space” conference at the Architectural Association with G. Celant, A. Buren, Eno, etc.

6. This purely sensory approach has been a recurrent theme in this century’s understanding and appreciation of space. It is not necessary to expatiate at length on the twentieth century precedents. Suffice it to say that current discourse seems to fluctuate between a) the 1910 German aesthetic overtones of the Raumempfindung theory, whereby space is to be “felt” as something affecting the inner nature of man by a symbolic *Einfühlung*, and b) one that echoes Schlemmer’s work at the Bauhaus, whereby space was not only the medium of experience but also the materialization of the theory. Much analysis of the “reality” of space has recently been done by artists in the last few years, especially with Vito Acconci’s performances (“Performing a space—my body should start to haunt the space between me and the box”), Irwin, Asher, Wheeler, and Nauman, whose spatial work tends to see visual and physical perception as restricted to the faintest of all stimulations. By a series of exclusions that become significant only in opposition to the remote exterior space and general social context, the “participant” only experiences his own experience. See also Roselee Goldberg’s “Space as Praxis,” *Studio International*, Sept.–Oct., 1975, and Germano Celant’s “Artspaces” in the same issue.

7. Cf. Bernard Tschumi, “Questions of Space: The Pyramid and the Labyrinth or the Architectural Paradox,” *Studio International*, Sept.–Oct., 1975, where the historical context of the paradox of space and the nature of its terms is discussed at length.

8. This infinite tension between the two mirrors constitutes a void. As Oscar Wilde once pointed out, in order to defend any paradox, the wit depends on *memory*. By absorbing and reflecting all infor-

mation, the mirrors—and the mind—become a wheel, a sort of circular retrieval system. In architecture, between the mirrors of ideal space and real space, the same thing happens. Long proscribed in an amnesic world where only progress and technological advance count, architectural memory returns. Cf. Antoine Grumbach, “L’Architecture et l’Évidente Nécessité de la Mémoire,” *L’Art Vivant*, no. 56, January 1975.

9. I only discuss here the resolution of the paradox in terms of a space *outside* the “subject.” The argument could indeed be extended to the unqualifiable pleasure of drawing and to what could be called the “experience of concepts.” Tracing Chinese ideograms, for example, means a double pleasure: for the experience of drawing reveals itself as a praxis of the sign, as a sensitive materiality with meaning. While with the paradox, it is tempting to try to uncover the mode of inscription of architectural concepts upon the unconscious. Especially if we admit that there is libido in all human activities, we may also consider that some architectural concepts are the expression of a sublimated model. See Sibony’s article in *Psychanalyse et Sémiotique*, 10/18 (Paris: Collection Tel Quel, 1975).

10. Too little research has been done on the relationship between architectonic concepts and the sensory experience of space: “Those who negate sensations, who negate direct experience, who negate personal participation in a praxis which is aimed at transforming reality, are not materialists” (Mao Tse Tung, *Four Philosophical Essays* [Peking: 1967]).

11. Le Corbusier, *Vers Une Architecture* (Paris: L’Esprit Nouveau, 1928). One chapter is entitled “Architecture et Transgression.” Not surprisingly, Le Corbusier’s interpretation considerably differs from Bataille’s and from the one discussed in my text.

12. *Ibid.*

13. *Ibid.*

14. Georges Bataille, *Eroticism* (London: Calder, 1962).

Figure Credits

Photographs courtesy the author

**Sensuality has been known  
to overcome even the  
most rational of buildings.**



VILLA SAVOYE, 1965

Architecture is the ultimate erotic act.  
Carry it to excess and it will reveal  
both the traces of reason and the sensual  
experience of space. Simultaneously.

Commentary, Bibliography, and Translations  
by Suzanne Frank

In the late 1960s the English little magazine *Form*, edited by Philip Steadman, began an admirable series of bibliographies of little magazines. These bibliographies were at once an objective record of history—a filling in of the received interpretation—and a mirror for the magazine's own activities. This sort of correction of perspective is often useful: hence, *Oppositions* offers its second bibliography of little magazines of the twenties and thirties (the first, on the magazine *Veshch*, appeared in *Oppositions* 5). In a sense, we are continuing in the tradition of *Form*. Further, we are filling in the gaps which it created. *Form* presented bibliographies of *De Stijl* and *Mecano* and thus, except for one issue of *Art Concret* (and *Holland Dada*, which was *Merz* 1), covered the entire little magazine production of Theo van Doesburg. However, there were two other Dutch little magazines which were published after the major polemical thrusts of *De Stijl* and *Wendingen* had been made, and they can be seen to reflect the less polemical and expanded cultural political consciousness of the next decade. One was *i 10*, and the other was *De 8 en Opbouw*. To suggest that *i 10* was the successor to *De Stijl* and *De 8 en Opbouw* the successor to *Wendingen* is to oversimplify the phenomenon of historical diffusion which can be observed in these two magazines. Rather, it is of more use to see *i 10* for what it is, a phenomenon of the second decade of the Modern Movement.

Suzanne Frank, an art historian whose particular interest is the Wendingen group of the early twenties, has done this bibliography of *i 10* for *Oppositions* (a second, on *De 8 en Opbouw*, will follow in a future issue). Her commentary, bibliography, and the two articles from *i 10* that she has translated, reveal an interesting synthesis of Russian political and European modernist attitudes as they were revealed in architecture, painting, poetry, music, and film—a cross-cultural attitude that is rarely seen in similar journals today.  
PDE

Suzanne Frank was born in New York in 1936 and received her B.S., M.A., and Ph.D. in Art History at Columbia University, New York. She is a Visiting Fellow and Senior Researcher at The Institute for Architecture and Urban Studies, where she is compiling files of articles by significant architectural writers. Her field of interests include Dutch architecture and planning and the work of CIAM. She is presently working on a book on the Amsterdam School.



One of the least known of the little magazines, according to the available histories of modern architecture, was the Dutch magazine *i 10*. It was born from the interests and associations of its chief editor, Arthur Müller Lehning.<sup>1</sup> Its policy developed from the views of Lehning and from those of its other three editors—J.J.P. Oud, Willem Pijper, and Lazlo Moholy-Nagy. Having studied history in his early years, Lehning became personally acquainted with writers such as Walter Benjamin. Mondrian, whom he met early in his career, gave him access to Oud, and this connection led to others. Pijper, who was involved in atonal music, was not as active in *i 10* as the other editors. Lazlo Moholy-Nagy was the only non-Dutch editor, and although he contributed in the areas of still-photography and typography, a Dutch counterpart, Menno ter Braak, wrote a series of articles on film which overshadowed Moholy's input. In all, the articles provided a broad cultural base within an overriding internationalist attitude.

It is this attitude which gives the magazine its distinct political flavor. In fact, the title can be seen to derive from several Russian sources. The first source is "0-10," the name of a group of Russian Futurist painters who exhibited in 1915-16 at the Stedelijk Museum, and a poster from that exhibition certainly must have influenced Lehning. But the title has further, perhaps less direct, identifications. One meaning of *i 10* apparently stems from Lucia Moholy's reference to the Tenth International, instituted in 1927 (and while this should not be taken as a sign of Communist affiliation, it certainly confirms the generally leftwing orientation of Lehning's policy); the second explanation of *i 10*, according to Lehning in the thirteenth issue of the magazine, comes from a play between alphabetical and numerical order—after "i" comes "j," the tenth letter in the alphabet. Thus the "i." which stands for internationalism, whether generalized or specifically the Internationale, is crucial for a comprehension of the title.

Political subjects, *neue Sachlichkeit* and Constructivist art and architecture, mechanical music, and film were all assembled under the rubric of the magazine. Although its political writings ranged from articles on Trotsky to commentaries on Mussolini, the general political coloring was

68 certainly of the Dutch left. In art and architecture there was little evidence of Expressionism, yet the line was certainly not De Stijl. In the writing of Stam, Oud, Moholy-Nagy, and Schwitters, Constructivist and Bauhaus attitudes were most pronounced. And while several languages were represented, the magazine was mainly written in Dutch and German with some French and English texts.

The design of *i 10* was straightforward, seemingly without the aesthetic rhetoric of *De Stijl* or *Wendingen*. Within the 8" × 11¾" format, Moholy-Nagy designed a sans serif typeface, which appeared in the first volume, before being replaced by a more conservative standard face. Cesar Domela's original cover design was used on every issue, with only a change in color marking each number. The grid design, with its play of titles and authors, reflects the *neue Sachlichkeit* and Constructivist tone of the magazine.

Like all little magazines, *i 10* seems to have had a predestined and limited lifespan. While its subscriptions increased from one hundred in 1927 to three hundred in 1929, there was no financial backing to support the continuation of the journal after 1929, and so it died after only twenty-two issues. In 1963, the Stedelijk Museum included *i 10* in an exhibition, and in the same year a facsimile edition was printed by Jong & Co. in Hilversum.

Finally, a note on the selection of the translations. We have focussed on two of the many articles on the Weissenhof Siedlung which appeared in no less than five issues of the magazine. The article by J.J.P. Oud confirms one's received view of his particular contemporary interests. However, the piece by Kurt Schwitters is a surprise. Here we find Schwitters—the iconoclast of the Merzbau and Dada manifestations—developing a serious socio-functionalist critique of Le Corbusier. It emphasizes the cultural and intellectual gap which often appears when non-architects are called upon to "read" architecture.

#### Note

1. Arthur Müller Lehning generously provided the following material on *i 10*. Earlier material was lost with the *i 10* archive in World War II. Arthur Lehning (111) een Gesprak van F. de Vree, interview, 26 June 1971; Introduction by Arthur Lehning for a reprint of one third of the original collection of *i 10* (The Hague: Bert Balcker, 1966. 2nd ed., Amsterdam, 1974); Lucia Moholy, "Internationale Avantgarde 1927-1929," *Du*, March 1964; "De internationale avant-garde tussen twee wereldoorlogen," *Goed wonen*, December 1963; Jacques den Haan and Arthur Lehning, "Een gedachten wisseling over de Internationale avant-garde tussen de twee wereldoorlogen," *de Syllabus, maandblad voor wetenschap en kunsten*, November 1963, pp. 33-35; "Avantgarde zwischen zwei Weltkriegen; Eine Erinnerung an die internationale Revue 'i 10'," *Deutsche Zeitung*, November 22, 1963; Arthur Lehning, "*i 10*: confrontatie met het heden," *Handelblad*, 15 November 1963; "Avant-gardisme van de 'i 10' weer herleefd," *Prov. Ov. en Zwolse Courant, Haarlems Dagblad, and Arnhemse Courant*, 5 and 19 October 1963; Fedde Schurer?, "*i 10*," *Friese Koerier*, September 5, 1963.

## Bibliography

Suzanne Frank

69

This bibliography has little structure. Although, at first, it seemed neat and manageable to classify the articles according to subject, I later fully realized that the purpose of the magazine, to be interdisciplinary, was so to the extent that one subject was meant to interact with another. Thus, instead of arranging the order by subject, or, in the case of art and architecture, media, I have categorized the articles according to issue. This could be tedious with, for example, *Gazette des Beaux Arts*, 1859-1939; 1942 ff., but here, with *i 10*, there are only twenty-two issues and three are double issues.

All the text was printed in Dutch, English, French, and German. Every title listed below with an English translation appeared in *i 10* in Dutch. The French and German titles have been left untranslated.

### *i 10*, no. 1, 1927

Behne, Adolf. "Wassily Kandinsky," p. 11. An obituary.

Biroekoff, Paul. "Het Leo Tolstoj-museum" ("The Leo Tolstoy Museum"), pp. 30-31.

Bloch, Ernest. "Doel" ("Purpose"), pp. 20-21.

Braak, Menno ter. "Filmkroniek" ("Film Chronicle"), pp. 39-40.

Holst, H. Roland. "Trotsky's Laatste Geschriften" ("Trotsky's Last Writings"), pp. 27-29.

Kandinsky, Wassily. "Und, Einiges uber Synthetsche Kunst," pp. 4-10.

Lehning, Arthur Müller. "*i 10*," pp. 1-2. Editorial.

Ligt, B. de. "Nieuwe wegen in de Wijsbegeerte" ("New Paths in Philosophy"), pp. 22-26.

Moholy-Nagy, L. "Geradigheid des Geistes Umwege der Technik," pp. 35-38. Photos and photomontages by Moholy-Nagy.

Mondrian, Piet. "De Woning-de Straat-de Stad" ("Dwelling-Street-City"), pp. 12-18.

Oud, J.J.P. "Richtlijn" ("Line of Action"), pp. 2-3.

Pijper, Willem. "Mechanische muziek" ("Mechanical Music"), pp. 32-34.

- 70 Ravestijnn, van. "Kantoorgebouw Goederen-Emplacement Feyenoord (Rotterdam) der Ned. Spoorwegen" ("Office building and warehouse, Feyenoord [Rotterdam] of the Dutch Railway"), p. 19. Illustrated.

**i 10, no. 2, 1927**

Benjamin, Walter. "Analytische Beschrijving van Duitsland's Ondergang" ("Analytic Description of Germany's Downfall"), pp. 50–55.

Braak, Menno ter. "Filmkroniek, *Metropolis*" ("Film Chronicle, *Metropolis*"), pp. 78–79. Illustrated with three film clips.

Brinkman and Van der Vlugt. Illustrations of Van Nelle factory, p. 42.

Descoendres, Alice. "Pestalozzi Revolutionnaire," pp. 72–75. Illustrated.

Ebneht, Lajos von. "Composition," p. 43.

Gumbel, E. J. "Sovjet-Rusland in 1926, pp. 58–68.

Holst, H. Roland. "Trotsky's Laatste Geschriften" ("Trotsky's Last Writings"), pp. 55–57. Conclusion.

Huszar, V. "De Reclame als Beeldende Kunst; Een inleidende beschouwing" ("The Poster as Fine Art: An Introductory View"), p. 49.

———. "Reclame Pav. Pier Scheveningen" p. 70.

L., A. M. (Arthur Müller Lehning). "Aanteekeningen: de onverantwoordelijke Anonymus" ("Annotations: the Irresponsible Anonymous Writer"), p. 71.

Moholy-Nagy. "Double portrait: fotogramm," 1926, p. 80.

Nettlau, Max. "Bemerkungen zur Einheit von Ost und West in B. de Ligt's Auffassung," pp. 68–70.

Oud, J.J.P. "Huisvrouwen en Architecten" ("Housewives and Architects"), pp. 44–48.

Romein, Dr. Jan. "De Buitenlandsche Politiek van Mussolini" ("The Foreign Politics of Mussolini"), pp. 75–78.

Stam, Mart. "M-Kunst" ("M[onumental]-Art"), pp. 41–43.

**i 10, no. 3, 1927**

Braak, Menno ter. "Russische Filmcultuur" ("Russian Film Culture"), pp. 118–120.

Eesteren. Cor van. "Over het Rokin-Vraagstuk" ("On the question of the Rokin"), pp. 82–85. Illustrated.

Ligt, B. de. "Nieuwe wegen in de Wijsbegeerte" ("New Paths in Philosophy"), pp. 97–103. Illustrated by Paul Meller.

Lissitzky, El. "Proun," p. 93. Illustrated.

Mierop, Lod. van. "Van Misdadiger tot Zielzieke" ("From the Criminal to the Mentally Deranged"), pp. 104–109.

Moholy-Nagy, Lazlo. "Die beispiellose Fotografie," pp. 114–117. Images of mechanical fantasy: photographs with multiple exposures and elongated images.

Opbouw. "Over Stedebouw" ("On City Building"), p. 81. Five points presented by the association, Opbouw.

Rietveld, Gerrit. "Nut, Constructie (Schoonheid: Kunst)" ("Use, Construction [Beauty: Art]"), pp. 89–92. Illustrated by Rietveld and Schroeder.

Romein, Dr. Jan. "De buitenlandse Politiek van Mussolini" ("The Foreign Politics of Mussolini"), pp. 110–113. Conclusion.

Stam, Mart. "Rokin and Dam, 1926," pp. 86–88. Illustrated, plus a perspective of the Van Nelle factory, Rotterdam.

Vantongerloo, G. "Principe d'Unité," pp. 94–96. Illustrations of two neo-plasticist sculptures and two diagrams.

**i 10, no. 4, 1927**

Acht, de. "De meening van 'de 8' over de tentoonstelling eindproject Hooger-Bouwkunst-Onderwijs (H.B.O.)" ("The opinion of 'de 8' on the exhibition of Higher Architectural Education"), pp. 126–127. Reproduction of the aims of 'de 8' as they appeared in that journal.

Binnendijk, D. A. M. "Dramatische Kroniek" ("Dramatic Chronicle"), pp. 158–159.

Bourgeois, Victor. "L'effort moderne en Belgique," pp. 121–12. Illustrations of the architect's work.

Braak, Menno ter. "Filmkroniek: *Iwan de Verschrikkelijke*" ("Film Chronicle: *Ivan the Terrible*"), pp. 159–160. Film clips of L. M. Leonidov and Veidt.

Eesteren, Cor van. Four illustrations of a design for a dwelling at the edge of a river, 1923, pp. 128–131.

Kallai, Ernst. "Malerei und Photographie," pp. 148–157. Illustrations of works by Hannes Meyer, Moholy-Nagy, Willy Baumeister, Spaemann-Straub, Irene Bayer-Hecht, and Lucia Moholy.

Mierop, Lod. van. "Van Misdadiger tot zielszieke" ("From the Criminal to the Mentally Deranged"), pp. 140–147. Continuation.

avesteyn, S. van. Two photographs of a radio set, 1927, p. 125.

Segal, Arthur. "Mein Weg der Malerei; aus einem vortrag," pp. 131–139. Illustrations of paintings by the author with formal affinities to orphist-cubism, and one illustration of a painting by Cesar Domela (1926).

#### i 10, no. 5, 1927

Braak, Menno ter. "Grondslagen der Filmaesthetiek" ("The Fundamentals of Film Aesthetics"), pp. 193–200. Illustrations from *De Moeder*.

Huszar, Vilmos. "De Reclame als Beeldende Kunst" ("The Poster as Fine Art"), pp. 161–163. Illustrations of two posters.

Ligt, B. de. "Nieuwe Wegen in de Wijsbegeerte" ("New Paths in Philosophy"), pp. 175–183.

Oerjger, Dr. Erna. "Wohnungsbau und Hausführung," pp. 166–174. Two illustrations of a house designed by Dr. Fritz Oerjger; three illustrations of Oud's design for the Werkbund Exhibition in Stuttgart.

Meller, Ir. Paul. Analytical photograph of a flower, to Mart Stam, p. 191.

Mierop, Lod. van. "Van misdadiger tot Zielszieke" ("From the Criminal to the Mentally Deranged"), pp. 185–191. Conclusion.

Palucca, Gret. Dance (a photograph), p. 192.

Switters, Kurt. An image with a yellow block, p. 183.

———. "Der Eine und der Andere," p. 184.

Stazewsky, H. A collage, p. 165.

Syrkus, S. "L'Architecture ouvrant le volume," pp. 163–165. Illustration of Malevich's suprematist sculpture.

#### i 10, no. 6, 1927

Baldwin, Roger N. "The Land of 'Liberty,'" pp. 211–214.

———. "Ontstaan en Doel der 'American Civil Liberties Union'" ("The Origin and Purpose of the 'American Civil Liberties Union'"), pp. 214–215.

Giedion, Sigfried. Blick vom pont Transpordeur Marseille, p. 228. Photograph.

Braak, Menno ter. "Grondslagen der Filmaesthetiek" ("The Bases of Film Aesthetics"), pp. 201–3. Conclusion.

Buchheister, Carl. "Komposition, Gleichseitiges Dreieck," p. 236.

"Diskussion über Ernst Kallai's Artikel 'Malerei und Fotografie,'" pp. 227–236.

Ehrenberg, Ilja. "Opmerkingen over de Cinema" ("Observations on the Cinema"), pp. 218–224.

Feininger, Lyonel. Model sailboat, p. 232. Illustration.

Foto construction Co-op, 1926/1, p. 229.

Kallai, Ernst. "Antwort," pp. 237–240.

Krenek, Ernst. "'Neue Sachlichkeit' in der Musik," pp. 216–218.

Lehning, Arthur Müller. "Aanteekeningen" ("Notes"), pp. 225–226.

Moholy-Nagy. Foto; Negative, 1927, p. 238.

Oud, J.J.P. "Internationale Architectuur; Werkbund-ten-toonstelling 'Die Wohnung' Juli-September 1927, Stuttgart" ("International Architecture; The Werkbund Exhibition 'The Dwelling', July-September, 1927, Stuttgart"), pp. 204–205. Refer to accompanying complete translation.

Renger-Patsch. Krötenpaar (photograph), p. 230.

72 Stam, Mart. "Autobus" ("Motor bus"), pp. 206-210. Illustrated.

**i 10, no. 7, 1927**

Alma, Peter. "Kunst en Samenleving" ("Art and Society"), pp. 241-244. Illustrations by Alma.

Benjamin, Walter. "Neue Dichtung in Russland," pp. 250-254.

Book reviews: Valeriu Marcu, *Der Rebell und die Demokratie, Zur Krise des Sozialismus* (Berlin: Laubsche Verlagsbuchhandlung, 1927); E. I. Gumbel, *Vom Russland der Gegenwart* (Berlin: Laubsche Verlagsbuchhandlung, 1927); *Fronta* herausgeben von fr. halas, vl. prusa, zd. rossmann, b. václavěk (verlag brün); *100 jahre lichtbild katalog der jahrhundert-ausstellung basel* (april-mai 1927); Karel Teige, *Stavba a básen* (Prague: verlag Olymp, 1927); Dr. Kurt Mühsam, *Berufsführer für film und kino* (Dessau: C. Dünnhaupt), pp. 257-258.

Braak, Menno ter. "Filmkroniek; Jazz" ("Film chronicle, Jazz"), pp. 278-280. Illustrated by film clips from the Paramount film *Jazz*.

Ehrenboerg, Ilja. "Opmerkingen over de Cinema" ("Observations on the cinema"), pp. 272-275. Conclusion.

Kallai, Ernst. "Der Plastiker Gabo," pp. 245-250. Illustrated.

Lasserre, Henri. "Une Expérience d'Association Communautaire; la Colonie de Llano, en Louisiane," pp. 262-266.

Müller-Lehning, Arthur. "Aanteekeningen; Cultuurnieuws" ("Notes: Culture News"), pp. 267-270.

Ligt, B. de. "Literatuur over China" ("Literature on China"), pp. 258-261.

Pijper, Willem. "Beethoven en de Jazz" ("Beethoven and Jazz"), pp. 276-278.

Schwitters, Kurt. "Sensation," pp. 270-271.

Stam-Lebeau, L. "Dichtkunst" ("Poetry"), pp. 255-256.

**i 10, nos. 8 and 9, 1927**

Berkman, Alexander. "The Tenth Anniversary of the Russian

Revolution," pp. 328-329.

———. "About American Justice," pp. 330-331.

Book reviews: Gaston Baty, *Le Masque et l'Encensoir* (Paris: Bloud et Gay, 1926); Paul Léautaud, *Le Théâtre de Maurice Boissard* (Paris: Nouvelle Revue Française, 1927); Ramon Gomez de la Serna, *Le Cirque* (Paris: Simon Kra, 1927); Philippe Soupault, *Coeur d'or* (Paris: Bernard Grasset, 1927); Henri Poulaille, *L'Enfantement de la paix* (Paris, Bernard Grasset); Henri Poulaille, *Ames Neuves* (Paris, Bernard Grasset); Pierre Girard, *Connaissez mieux le coeur des femmes* (Paris, Simon Kra, 1927); Martin Maurice, *Nuit et Jour* (Paris: Nouvelle Revue Française, 1927); *Anthologie de la nouvelle prose française* (Paris: Simon Kra, 1927); Henri Barbusse, *Les Bourreaux—Dans l'enfer de l'Europe* (Paris, Editeur Ernest Flammarion), pp. 320-327.

Ebneth, Lajos von. "Reclame" ("Poster"), pp. 317-318. Illustrated.

———. "Dynamische Compositie" ("Dynamic Composition"), p. 319.

Eesteren, C. van. "Naar Aanleiding van de Prijsvraag voor een Watertoren te Wassenaar" ("On the Occasion of the competition for a water tower in Wassenaar"), pp. 286-289. Illustrated.

"Japanische Fotografie" ("Japanese Photography"), pp. 338-340.

Krapotkin, Peter. "De Ethiek van Guyau" ("The Ethics of Guyau"), pp. 295-300.

Lasserre, Henri. "Une Experience d'Association Communautaire; La Colonie de Llano, en Louisiane," pp. 290-294. Conclusion, illustrated.

Ligt, B. de. "La philosophie comparée," pp. 300-311.

Oud, J.J.P. Three photographs of workers' housing with shops, pp. 281-285.

Romein, J. "De Vlootconferentie van Geneve" ("The Naval Conference of Geneva"), pp. 331-337.

Schwitters, Kurt. "Anregungen zur Erlangung einer Systemschrift," pp. 312-316.

Wilker, Karl. "Vom Sinn der Freiheit in der Erziehung; Konferenz der Internationalen Liga für neue Erziehung," p. 327.

**i 10, no. 10, 1927**

Book review: Katherine Mayo, *Mother India* (London, Jonathan Cape), pp. 370–372.

Ehrenboerg, Ilja. “Martijn van Brood,” pp. 357–363. Illustration of painting of Cesar Domela and a composition by Vordemberge-Gildewart, 1927.

Krenek, Ernst. “Mechanisiering der Künste” (“Mechanization of the arts”), pp. 376–380. Illustration of compositions by Cesar Domela and Lajos von Ebnech.

Lehning, Arthur Müller. “Aanteekeningen Waarheen gaat Coster?” (“Annotations to Whither goes Coster?”), pp. 364–365.

Moholy-Nagy, Lazlo. Photographs, pp. 374–375.

Oud, J.J.P. “Aangepast bij de Omgeving” (“Adapted to the surroundings”), pp. 349–356. Illustrated with a construction by Vantongerloo and a poster by van Huszar.

Romein, J. “Gorter,” pp. 366–369.

Schwitters, Kurt. “Stuttgart, Die Wohnung; Werkbundaussstellung,” pp. 345–348. Refer to accompanying complete translation.

Stam, Mart. “Drie Woningen op de Tentoonstelling te Stuttgart” (“Three Dwellings at the Exhibition in Stuttgart”), pp. 342–345. Illustrated.

Velde, Marcel van de. “België bedreigd” (“Belgium Threatened”), pp. 372–373.

**i 10, no. 11, 1927**

Book reviews: Wera Figner, *Nacht über Russland. Lebenserinnerungen* (Berlin, Malik-Verlag); Angelica Balabanoff, *Erinnerungen und Erlebnisse* (Berlin: Laubsche Verlagsbuchhandlung, 1927); Alexander Berkman, *Die Tat. Gefängniserinnerungen eines Anarchisten* (Berlin: Verlag Der Syndikalist, 1927); Ernst Toller, *Justizerlebnisse* (Berlin: Laubsche Verlagsbuchhandlung, 1927); Harry Domela, *Der falsche Prinz* (Berlin, Malik-Verlag); Dr. Siegfried Bernfeld, *Sisyphos, oder die Grenzen der Erziehung* (Internationaler Psychoanalytischer Verlag, 1925); Otto Rühle and Alice Rühle-Gerstel, *Am andern Ufer* (Blätter für sozialistische Erziehung I-V. Dresden, Verlag Am Andern Ufer); Colin Ross, *Die erwachende Sphinx* (Leipzig: F. A. Brockhaus, 1927); *Das*

*Flammenzeichen vom Palais Egmont* (Berlin, Neuer Deutscher Verlag); J. H. Bolt, *Nieuwe Wegen in Opvoeding en Onderwijs* (Zeist: Ploegsma, 1927), pp. 412–414.

Braak, Menno ter. “Filmkroniek” (“Film chronicle”), pp. 419–420. Illustrated with photographs by Cousemüller.

Kern, Walter. “Film als Kunst; Ein Beitrag zur Aesthetik des Films,” pp. 416–418. Illustrated by Moholy-Nagy, Der Wasserkopf, and Mord auf den Schienen.

Oud, J.J.P. “Toelichting op een Woning-type van de Werkbundaussstellung ‘Die Wohnung’, Stuttgart, 1927” (“Explanation of a Dwelling Type at the Werkbund exhibition ‘Die Wohnung’, Stuttgart, 1927”), pp. 382–384. Illustrated.

———. “Wohin führt das neue Bauen: Kunst und Standard,” pp. 385–386. Illustrations of Oud’s Stuttgart designs.

Romein, J. “Tien Jaren, 1917–1927” (“Ten Years: 1917–1927”), pp. 408–411.

Schapiro, A. “La Révolution Russe à vol d’Oiseau,” pp. 402–407.

Schwitters, Kurt. “Meine sonate in urlauten,” pp. 392–402. Photograph by Cousemüller.

Vantongerloo. “Réflexions sur l’existence absolue des choses,” pp. 387–391. Conclusion; photograph by Cousemüller.

**i 10, no. 12, 1927**

Bloch, Ernst. “Metaphysisches zu Fidelio,” pp. 431–432.

Book review: *Die Vollkommene Ehe* (Leipzig, Medizinischer Verlag), pp. 459–460.

Braak, Menno ter. “De Zin van Rhythme en Vorm in de Film” (“The Sense of Rhythm and Form in Film”), pp. 454–459.

“Exodus, I,” p. 445.

Gumbel, E. J. “Landesverrat in Deutschland,” pp. 446–449.

Huszar, V. A poster, p. 453.

Lehning, Arthur Müller. “Aanteekeningen; toch Schuldig?” (“Notes; Still Guilty?”), p. 444.

Ligt, B. de. “De Leidsche Cocktailmixer; Een publiek persoon”

74 ("The 'Leidsche' Cocktail Mixer; A Public Person"), pp. 450–453. Photograph of B. de Ligt.

Mondrian, Piet. "De Jazz en de Neo-Plastiek" ("Jazz and Neo-Plasticism"), pp. 426–427. Illustration of Mondrian's Neo-plastic painting.

Roubakine, N. "La Science du Livre et de son Influence sur l'Individu et l'Humanité; La Psychologie Bibliographique," pp. 433–443.

Stam, Mart. "Ontwerp Watertoren" ("Water tower project"), pp. 428–431. Illustrated.

#### i 10, no. 13, 1928

Book review: L. Moholy-Nagy, *Malerei, Fotografie, Film* (Munich: Bauhausbücher, 1927), pp. 20–23.

Grote, Ludwig. "Bühnenkompositionen von Kandinsky," pp. 4–5. Illustrated.

Gumbel, E. J. "Klassenkampf und Statistik; Eine Programmatische Untersuchung," pp. 14–19. Part I.

Ivens, Joris. "De Brug" ("The Bridge"), pp. 10 and 19. The latter are film strip illustrations.

Leck, B. van der. Illustration of Factory exit (1912), p. 24.

Lehning, Arthur Müller. "Bij het Dertiende Nummer" ("On the occasion of the Thirteenth Issue"), pp. 1–2.

Lehning, Arthur Müller and Thompson, William G. "Vanzetti's laatste Gesprek" ("Vanzetti's Last Conversation"), pp. 10–12.

Lehning, Arthur Müller. "Aanteekeningen; 'Bett und Sofa' en de Goede Zeden" ("Notes; 'Bed and Sofa' and Good Morals"), pp. 21–22.

Palucca, Fret. Photograph, p. 20.

Poulaille, Henri. "Le Vrai Visage de la France," pp. 6–10.

Rietveld, G. "Garage met Chauffeurswoning" ("Garage with Chauffeur's Lodging"), p. 13. Photograph and plan.

Stam, Mart. "Paleis van den Volkenbond" ("Palace of the League of Nations"), pp. 2–3. Illustrated.

#### i 10, no. 14, 1928

Book reviews: Adolf Behne, *Neues Wohnen-Neues Bauen* (Leipzig); Ludwig Hilbersheimer, *Grosstadtarchitektur* (Stuttgart, Uitgever Julius Hoffmann); Peter Meyer, *Moderne Schweizer Wohnhäuser* (Zürich, Uitgever Dr. H. Girsberger & Cie.); Walter Gropius, *Bauhausbücher: Internationale Architektur* (Munich, Albert Langen, 1928).

Gorki, Maxim. "Wladimir Lenin," pp. 41–43. From Gorki's *Erinnerungen an Zeitgenossen*, part XIII in the collected works; photographs of Lenin and Gorki after the revolution.

Gumbel, E. J. "Klassenkampf und Statistik; Eine programmatische Untersuchung," pp. 33–38. Continuation.

Kiljan, G. Poster of gas stove, p. 29.

Nettlau, M. "Nie Wieder Diktatur; Over de mogelijkheid, de diktatuur binnen het raam der richtingen en organisaties, die streven naar het socialisme, uit te schakelen" ("Never again Dictator; on the possibility of ruling out dictatorship within the framework of the directions and organizations which strive toward Socialism"), p. 43–48.

Oud, J.J.P. "Beursproject 1926" ("Stock Exchange Project"), pp. 25–29. Illustrated.

S., L. "Internationale Architectuur Tentoonstelling 'Opbouw', Rotterdam" ("International Architectural Exhibition 'Opbouw', Rotterdam"), p. 29.

Tolstoi, Leo. "Tolstoi en de Revolutie" ("Tolstoy and the Revolution"), pp. 39–40. Introduction by Arthur Müller Lehning; photograph of Tolstoy and Gorki, 1900.

"Vorbereitender Internationaler Kongress fuer Neues Bauen im Chateau de La Sarraz, 25/29 June 1928," pp. 30–31.

#### i 10, no. 15, 1928

Anonymous. "Die Normung in den Vereinigten Staaten," p. 55.

Book reviews: Adolf G. Schneck, *Der Stuhl* (Stuttgart, Julius Hoffmann, 1928); Maxim Gorki, *Erinnerungen an Zeitgenossen* (Berlin: Malik-Verlag, 1928); Ilja Grewsdew, *Das Leben Gorki's, Biografie* (Berlin: Malik-Verlag, 1928); B. de Ligt, *Nieuwe Vormen van Oorlog en hoe die te bestrijden* ("De Tijdstroom," 1927); Barthelemy de Ligt, *Contre la Guerre nouvelle* (Paris: Rivière, 1928); *Das Neue Frankfurt*, Ernst May and Fritz

Wichert, eds. (Frankfurt, Englert und Schlosser); *Bauhaus*, Zeitschrift für Gestaltung, Hannes Meyer, ed. (Dessau), pp. 64–66.

Ct., N. R. (Nieuwe Rotterdamsche Courant?). “Autobussen over lange Afstanden” (“Long distance buses”), p. 72. Photograph of a Detroit bus.

———. “Een belangrijk conclusie in het belang der verkeerswegen” (“An Important conclusion in the interest of road ways”), p. 72.

Eesteren, Cor van. “Nieuwe actie tegen het erfpachtstelsel” (“New Action against the long-lease system”), p. 59.

Gumbel, E. J. “Klassenkampf und Statistik; Eine programmatische Untersuchung,” pp. 56–59. Conclusion.

Holm, K. Lönberg. “America,” pp. 49–55. Illustrated.

Kramer, Ferdinand. Illustration of a Thonet chair, p. 65.

Leck, B. v. d. “Op de Markt, 1913” (“In the market place, 1913”), p. 67.

———. “Olifant, 1924” (“Elephant, 1924”), p. 68

Lehning, Arthur Müller. “Wij en Tolstoi” (“Tolstoy and Us”), pp. 61–64. Speech given in Amsterdam, 22 September 1928.

Marsman, H. “Gorter,” pp. 59–61.

Moholy-Nagy, Lazlo. “Zum Sprechenden Film,” pp. 69–71. Illustrated by news-clippings on “talking movies.”

———. “Die Normung in den Vereinigten Staaten, p. 55. Illustrated.

#### i 10, no. 16, 1928

Braak, Menno ter. “Filmkroniek: *La Coquille et le Clergyman*” (“Film Chronicle: *La Coquille et le Clergyman*”), pp. 84–85.

Ct., N.R. “‘Aangepast aan de Omgeving’; Het Volkenbondspaleis” (“Adapted to the Surroundings; the Palace of the League of Nations”), p. 79. Illustration of the Van Nelle Factory in Rotterdam.

Eesteren, C. van. “Woonhuis te Nunspeet 1926” (“House in Nunspeet”), pp. 80–82. Illustrated.

Lehning, Arthur Müller. “Aanteekeningen; Koepokken, Dienstplicht en Abortus” (“Notes; Cow-pox, Conscriptio and Abortion”), pp. 78–79.

Ligt, B. de. “Événements Philosophiques,” pp. 86–88.

Rietveld, G. Design of a metal stool, p. 65.

Schuitema, Paul. “Reclame Paul Schuitema,” pp. 76–77. Illustrated; comparison of old and new posters.

Schwitters, Kurt. “Werkbundtagung in München, 1928,” pp. 73–75.

“VI Internationaler Kongress für Zeichen, Kunstunterricht und Angewandte Kunst in Prag, 29 Juli–5 August 1928,” pp. 82–84.

#### i 10, nos. 17 and 18, 1928

Benjamin, Walter. “Karl Kraus,” p. 113.

Behne, Adolf. “AHAG-Ausstellung,” pp. 94–95. Three photographs.

Book reviews: Henri Massis, *Défense de l'Occident* (Paris, Plon); Julien Green, *Andrienne Mesurat* (Paris, Plon).

Bloch, Ernst. “Notizen zum Problem Strawinsky,” pp. 98–100.

“Chez Pander Anno 1928,” p. 97. Illustrated.

Eesteren, C. van. “Ontwerp: Rokin” (“Design: Rokin”), p. 108. Illustrated.

“Geestelijke Hygiene” (“Spiritual Hygiene”), p. 90. Illustrated.

Gelder, G. van. “China en het Westen” (“China and the West”), pp. 103–107.

Lehning, Arthur Müller. “Aanteekeningen; ‘Massachusetts the Murderer’ en een Amsterdamsch advocaat” (“Notes; ‘Massachusetts, the Murderer’ and an Amsterdam lawyer”), pp. 100–102.

Moholy, Lucia. “VI Internationalerkongress für Zeichen, Kunstunterricht und Angewandte Kunst in Prag, 29 Juli–5 August 1928,” pp. 96–97.

M-n. (Moholy-Nagy?). “Zu den fotografien von Florence Henri,” pp. 117–118. Examples of the photographer’s work.

———. “Filmkroniek” (“Film Chronicle”), pp. 118–120. Illustrated with stills of the films: *Das kind des anderen* and *Johanna van Orleans*.

Nettlau, M. “Nei wieder Diktatur, II” (“Never again Dictatorship, II”), pp. 109–113.

Picasso, Pablo. “La Fenêtre Ouverte,” p. 91. Illustration.

Rietveld, G. “Inzicht” (“Insight”), pp. 89–90.

———. “Kleine Woningen te Utrecht” (“Small Houses in Utrecht”), pp. 91–93. Illustrated.

———. Photograph of a house in Wassenaar (1924), p. 108.

Van Nelle Factory, Rotterdam, view, p. 113.

#### i 10, no. 19, 1928

Arp, Hans. “Nabel Tische Beine,” pp. 121–122.

Book reviews: Erich Mendelssohn, *Russland, Europa, Amerika* (Berlin, Rudolf Mosse Buchverlag); Julius Vischer, *Ludwig Hilberseimer. Beton als Gestalter* (Stuttgart, Verlag Julius Hoffmann). Menno ter Braak, *Cinema militans* (“De Gemeenschap,” Utrecht, 1929); Wera Figner, *Nach Schlüsselberg. Dritter teil der Lebenserinnerungen* (Berlin, Malik-Verlag); Otto Rühle, *Karl Marx. Leben und Werk* (Dresden, Verlag Hellerau).

Braak, Menno ter. “Filmkroniek: *Chapeau de Paille d’Italie*” (“Film Chronicle: *Chapeau de Paille d’Italie*”), pp. 140–142. Illustrated with stills from the film.

Brancusi. Photographs of four sculptures: *La Sorcière*, 1914–23, p. 122; *L’enfant prodigue*, 1915, p. 127; *Léota*, 1923, p. 127; untitled, 1926, p. 132.

Doorenbos, Jenne Clinge. “Gorter’s ‘Dagboek’” (“Gorter’s ‘Diary’”), p. 127.

Laban, Rudolf. “Tanz und Musik,” pp. 132–135.

Lehning, Arthur Müller. “Aanteekeningen; de Zedelijkheid der Censuur” (“Notes; the Morality of Censorship”), pp. 128–131.

———. “Herman Gorter,” pp. 125–127.

Ligt, B. de. “Proef op de som” (“Proof of the Pudding”), p. 140.

M-n. “Filmkroniek: *Sturm über asien*”, pp. 143–144. Three stills.

Oud, J.J.P. “In Memory of Peter van der Meulen Smith 1902–1928,” pp. 122–123. Illustrated.

Schuitema, P. “Letters: Het Materiaal van den Drukker” (“Letters: The Material of the Printer”), p. 124. Illustrated.

“Symbolism of Architecture,” p. 132. Photograph of the main gate of the Water Tower in Wassenaar.

#### i 10, no. 20, 1928

Bloch, Ernst. “Lied der Seerauberjenny in der Dreigroschenoper (Kurt Weill und Lotte Lenja mit Gruss),” pp. 153–154.

Book reviews: Knud Rasmussen, *Zwei jahre im schlitten durch unerforschtes eskimoland* (Frankfurt, Abteilung Buchverlag); L. Fawcett, *Die Welt des Films* (Leipzig: Amalthea Verlag, 1928).

Brockway, A. Fenner. “England’s next Labor Government,” pp. 150–153.

Eesteren, C. van. “Prijsvraag Ontwerp voor een Aula des Landbouw-Hoogeschool te Wageningen” (“Competition entry for a Meeting Hall for an Agricultural College at Wageningen”), pp. 145–149.

Hitchcock, Henry-Russell, Jr. “America-Europe,” pp. 149–150.

Holst, A. Roland. “Een Limerick op een Slimmerik (“A Limerick on a ‘Slimmerick’”), p. 168.

Lehning, Arthur Müller. “Aanteekeningen; Het Groote Démenti” (“Notes; the Great Denial”), pp. 157–162.

Moholy-Nagy. “Schart oder unschart?” pp. 163–167. Illustrated.

Posse, Ernst H. “Georges Sorel (1847–1922),” pp. 155–156.

Werkbund-Ausstellung, Film und Foto, Stuttgart 1929, p. 153.

#### i 10, nos. 21 and 22, 1928

Book reviews: Roger N. Baldwin, *Liberty under the Soviets* (New York: Vanguard Press, 1928); Lucy L.W. Wilson, *The New Schools of New Russia* (New York: Vanguard Press, 1928);

Jessica Smith, *Woman in Soviet Russia* (New York: Vanguard Press, 1928); *Handbuch des aktiven Pazifismus* (Zurich and Leipzig, Rotapfelverlag); Otto Lehmann-Russbuldt, *Die blutige Internationale der Rüstungsindustrie* (Hamburg: Fackelreiter-Verlag, 1929); John Dos Passos, *Manhattan Transfer* (New York and London, Harper and Brothers); *Upton Sinclair* (Boston and New York, Albert and Charles Boni: German edition, Berlin, Malik Verlag); Gustav Landauer, *Sein Lebenswerk in Briefen* (Frankfurt am Main: Rutten & Loening, 1929); Hans Driesch, *Die sittliche Tat* (Leipzig, Reinecke); A. Schweitzer, *Kulturphilosophie I. Verfall und Wiederaufbau der Kultur II* (Munich, Beck); Paul Feldkeller, *Verständigung als philosophisches Problem* (Erfurt, Stenger).

Braak, Menno ter. "Filmkroniek; *tien dagen, die de wereld deden wankelen*" ("Film Chronicle; *Ten days which rocked the world*"), pp. 188-189.

"Een Leerschool van den Leugen" ("A school of lies"), p. 188.

Eesteren, C. van. "Städtebau," pp. 169-173. Illustrated with an office by G. Rietveld, perspectives of a house by P. Elling, and a desk by van Ravesteyn.

Exhibition of "Neues Haus" in Brünn, Czechoslovakia, 1928, p. 176.

"Kroniek" ("Chronicle"), p. 176.

Last, Jef. "Furcht vor der Welt; ein Scenario von Jef Last," pp. 177-181. Illustrated.

Lehning, Arthur Müller. "Aanteekeningen; de Reddende Prijsvraag" ("Notes; The Competition at the Rescue"), pp. 181-184.

Moholy-Nagy. "Fotogramm und Grezgebiete," pp. 190-192. Illustrated.

Nettlau, M. "Nie wieder Diktatur" ("Never Again Dictatorship"), pp. 184-188. Conclusion.

Photograph of *Credo in Unam Sanctam* and other yearbooks, p. 176.

Schwitters, Kurt. "Urteile eines Laien über neue Architektur," pp. 173-176. Illustrations of a house in Utrecht by van Ravesteyn.

1 Weissenhof Siedlung, Stuttgart, 1927. A few names are incorrect. The house attributed to Poelzig is by Bruno Taut, Poelzig's house is next to Hilberseimer's house, and the house attributed to Bruno Taut is by Max Taut.

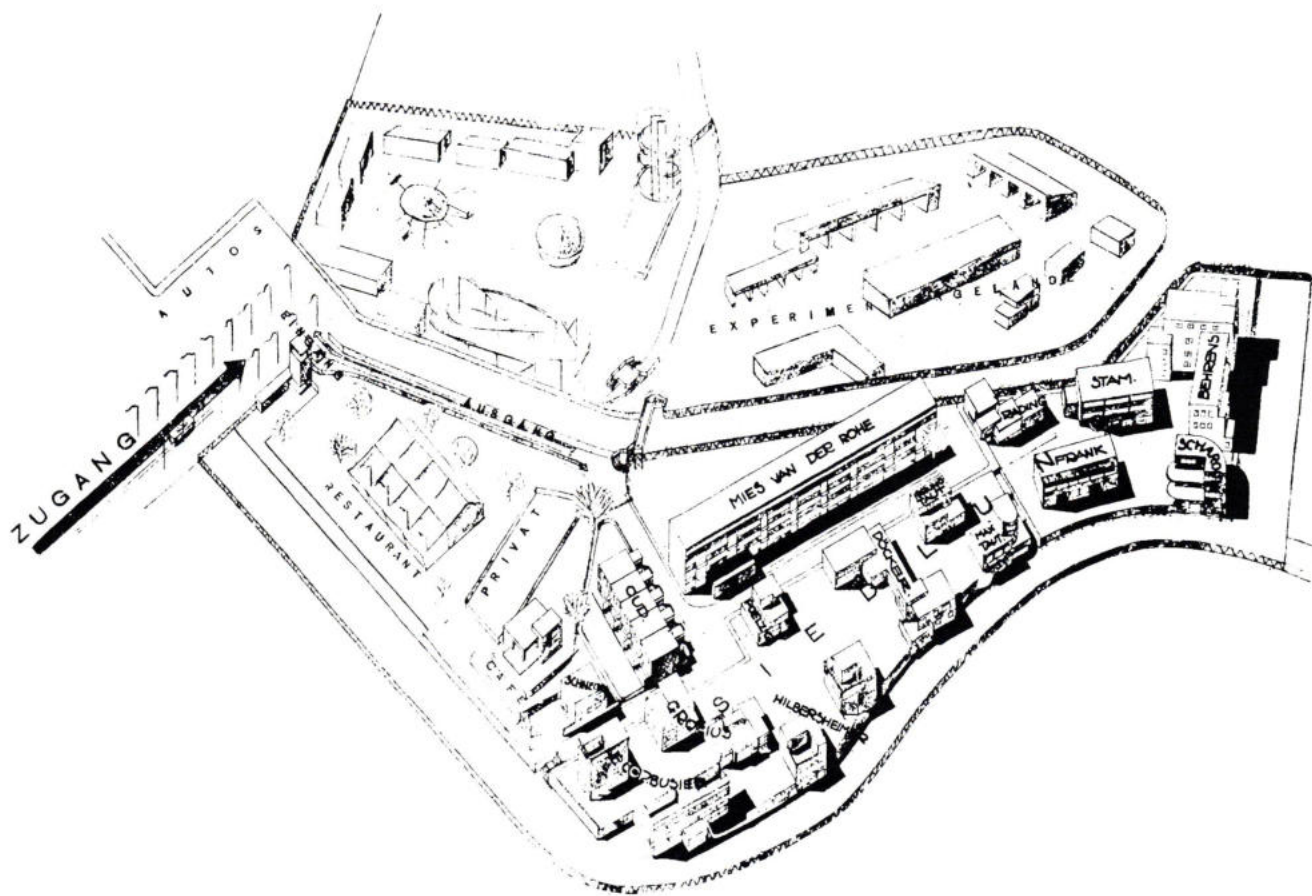

**International Architecture: Werkbund Exhibition,  
“The Dwelling,” July–September 1927, Stuttgart.<sup>1</sup>**

J.J.P. Oud

Translation by Suzanne Frank

This illustration (fig. 1) provides a view of the exhibition to be held by the “German Werkbund” from July to September in Stuttgart, a unique occasion in the field of exhibitions. As part of the city of Stuttgart’s program to build a great number of dwellings, the German Werkbund was given permission to build over sixty dwellings as model dwellings—model dwellings not in the sense of extraordinary dwellings that function merely as non-essential show-pieces during the exhibition, but dwellings to be shown for inspection during the first three months after the building, and afterwards to be inhabited, proving that they are more than just objects of exposition.

Although the Werkbund is allowed to experiment in a constructive way with the problem of improving the household, and although architectonic freedom in every respect is guaranteed, there is a fundamental demand that the dwellings be useful.

Those directions and solutions that will be of general interest can probably be mentioned here. A first drawing, which gives a survey of the building site according to the design drawings of the architects, points to an important phase in the development of the new architecture. The leading architect, Mies van der Rohe designated an Austrian, a French-Swiss, a Belgian, two Dutch, and a number of other Germans as architects for the various groups of buildings.

It is striking to find out from this drawing that there already exists within the work of such an international group of architects such a striking unity of conception that in the grand view of a single scheme one could say it expressed one spirit. And this has occurred despite the fact that the chief architect does not want to regulate his colleagues any further than to specify the parcelling of the land for the residences and to indicate the building heights!

Those who think that the new architecture is on the wrong track because it does not recognize the individual sensibility of the artist who prefers to live his life to the full, rather than worry about the morality of his commissions, here would perhaps detect something new that only in past times appeared possible: unity. Unity is generally much more

important than being different, however good it may be to be different. In the architecture of the period directly preceding ours, the architecture was unimportant since the individual thought himself to be of more significance than his commission: in the modern period, architecture will blossom again since the architect is willing to make himself subordinate to his commission. Therefore, the elements of elitism and status disappear from architecture. Architecture creates no more heights of proud willfulness and no more depths of crude striving-for-effect; thus quality and style originate. Architecture “serves” again, and it tries to serve with lucidity and a lack of complexity. It is again in touch with life; it becomes as resilient as life itself, which penetrates it everywhere. There are no pretty or ugly sides anymore, no more back or front; it is like nature, its trees and plants. It is—in a deeper sense than today’s slogans imply—“organic.” The drawing above represents the beginning of such an anonymous architecture. What is present here in the germ of an idea is above style-searching and no longer may be destroyed. The new architecture has outgrown the era of the wooden hammer!

Note

1. J.J.P. Oud, “Internationale Architectuur; Werkbund-tentoonstelling ‘Die Wohnung’, Juli–September 1927, Stuttgart” (International Architecture: Werkbund Exhibition, ‘The Dwelling’, July–September 1927, Stuttgart), *i 10*, no. 6, 1927, pp. 204–205.

## Stuttgart, "The Dwelling," Werkbund Exhibition<sup>1</sup>

Kurt Schwitters

Translation by Suzanne Frank

80

The people want to believe, and the thinking man wants to see, wants to travel in order to see. This statement by Rosenberg applies to the Stuttgart exhibition, "The Dwelling," of 1927. The people of the city who want to believe, who are laymen in this case, to be sure do not understand much about architecture, but they readily believe that the exhibition of the city of Stuttgart, "their" exhibition, is good. This makes for big speeches, on the order of "if also . . . thus. . . ." Moreover, none of the many official speeches is free of the undertone "one can, to be sure, talk or think about that, as one desires . . . but. . . ." They definitely feel that something is happening, yet they simply do not understand why. It is not the exhibition and the settlement which convince them but the fact that men of intelligence have travelled here in order to see it. At the occasion of the opening they all came together to meet. In addition, Herr Werner Gräff developed direct and exciting propaganda for the exhibition, so that it would not only be an outlet for "men of spirit" but also something believable for people of all countries.

But I think that the authorities in Stuttgart and Württemberg are like chickens that have hatched false eggs and now stand at the shore of the pond and watch with pride and horror as the chicks, which they still consider their children, swim far away over the water's surface where they cannot follow them. A beautiful image, eh? And the mother hen calls and tries to attract her water babies, even if to no avail.

But here in Stuttgart at the official dinner, the opposition, who was sitting at the table of the administration in the form of an old representative of the Tübingen University, finally confessed his need to act as "home policeman," as he called himself, and mentioned that Stuttgart lies not in Holland or California and for that reason the flat roof does not belong here. According to him, the flat-roofed house is what flat feet are for people because it is "platter" roofed. The "policemen" was finally thwarted from bringing forth still more platitudes concerning the flat roof since this "platt" discussion did not make up part of the agenda, and since most of the guests were eating so loudly that no one could understand him anyway. An especially impudent eat-

ing guest with an oval face even said: "Accordingly, nobody has asked him about this," which aroused general serenity, as official dinners usually do. But is it not also natural that an old professor like this should not be able to accustom himself to a new era in one day? For the short span from 1918 to 1927 is not really long enough. If someone has been able to travel for sixty years and then suddenly acquires flat feet, he simply buys equal supports for his arches. One could see or feel that this man's remarks were in the nature of an arch support, even though all later speakers tried to conceal the unpleasant impression. And I also tried to do the same. As my mother always used to say: "Like children, they do not want to say it, and then suddenly they say an enormous, enormous stupidity." I then toasted Mies van der Rohe, saying I had pity for him since now he would not be permitted to build flat roofs anymore, but he accepted it very fast and laughed heartily at the whole thing. I have never before seen him laugh so much about anything.

But you want to know why I have told you all this. Yes, the connection is that out of this spirit the whole exhibition and the entire Weissenhof Siedlung was born.

Many talk when they speak of Württemberg of the "*Creischschewahn*." And if a Berliner or Mr. Westheim himself would have listened to the speech that we people of Stuttgart in "*Schtuggert*" have created all this because we can create architecture just as good and new as the people of Berlin, and because we have a very good "*Schabischer*" blockhead which maybe only saw the "*Rauscheschebaart*" as the Berlin people are. But unjustly so, because there is a great flexibility in the "people" of the "*Wirtteberger*." I wish to "*Cott*" (God) that we in Hanover would not have had the typhoid bacillus but a man like Bazille, the patron of the exhibition, then perhaps for once we would have been able to bring about a good exhibition. Because the exhibition is really "*mischtergiltig*," and the settlement, even if problematic, is also a very great act.

The choice of photos from the book *The International Architecture* by Ludwig Hilberseimer is quite comprehensive, and the grouping is instructive. If I had been one of the many speakers, then I would have said that we owed Hil-

berseimer thanks, but of course all speeches terminate with the expression that we owe thanks to someone. I was at that time in such a thankful mood that I was thankful to all the people who were walking around in Stuttgart because I could not distinguish who all the thanks belonged to individually. And now the Weissenhof Siedlung. 81

"Thanks" for the grouping of the entire Siedlung belong to Mies van der Rohe. "He has masterfully understood it . . .," in order to speak in the spirit of the speaker; he has masterfully understood how to adjust the total plan to the site. Mies determined the position and size of the houses. The individual architects gave the best of their best. Nevertheless, it remains a crazy idea that so many prominent champions of architecture and Werkbund members of our time should build houses in such close proximity to each other. Such heterogeneity must be sudden. However, each architect has considered the other houses as much as possible. As the subject of an exhibition it is extraordinarily instructive, but I do not need to live there. Extremely strong personalities like Peter Behrens and Hans Poelzig suddenly build here, out of pure courtesy to the young, houses in which they themselves do not believe and in which I do not believe either. Poelzig has made a beautiful Italian Villa according to the new style, and Peter Behrens has built a house with no character whatsoever—it is, in general, just modern. Too bad! Why then this pretense? Nevertheless, Behrens is still very important for this development. He was one of the most important champions of the new architecture. Why does he permit a twenty-five percent interest to be introduced here because of his contemporary building manner? Why this higher valuation mortgage? Does he no longer believe in himself? He is unfortunate if he doesn't. For the observer it would be more interesting to see, beside Mies, Oud, Gropius, Stam, and Le Corbusier, the genuine Behrens and the genuine Poelzig. This way one cannot really compare them.

One cannot judge the work on principle entirely, since the gentlemen, while they have solved all their programs differently, have kept more or less to the same guiding principles. For example, Gropius alone tested a unique new building manner, while all the others built in their accustomed

manner with or without loans. The attempt to try out new building materials is of interest to Gropius alone. Also, not all of them have conformed to the dimensions of the blue prints; for instance, Le Corbusier built both of his houses too large which very much disturbs the overall impression. Indeed, Le Corbusier is not entirely harmless, since he is a highly gifted, talented architect, but, alas, romantically inclined. I consider him just as dangerous to sound architecture as Dudok and de Klerk. Or am I perhaps wrong? Perhaps some people find these imposing buildings by Le Corbusier fabulous. But they are being fooled. My grandmother always said, "do not let yourself be fooled!" and I certainly try not to be. I carefully consider *sine ira*: if an iron column stands before the window in the middle of a room, what does that mean? Aha, what occurs is that one has continuous rows of windows outside. Is there, therefore, a principal distinction between this building and the slaughterhouse by Dudok in Hilversum, which is in its front facade a stronghold with solid walls and in the rear a factory, since the light must come from somewhere? Now you can also find in the house by Le Corbusier a living room, separated by a half wall, which includes a bath-tub. Why? Because of the steam? Is this healthy or hygienic? I look further and find beside it a toilet door, which opens into the room, clearly it is there, it seems to me, because of the odor. The main room takes up two floors. Why? If one makes a fire it is still not warm below, even when one can no longer endure the heat from above. Or maybe the house is actually built for a southern climate where one does not make fires? Though unfortunately it now stands in Stuttgart. It is a pity, and I ask myself why? Also, in favor of this southern climate idea are the tremendous balconies which one can seldom use in the climate of Stuttgart. Can Le Corbusier's house favorably influence the climate in Stuttgart and thus change it? Maybe through secret forces? Or is this romanticism? Only with difficulty can I orient myself to these ideas. Is nature created in this manner? Moreover, the view is apparently considered superfluous since, in the main space of the one-family houses, there is no window on the wall which would have the best view. But I will say nothing, because I know very well what great respect Le Corbusier enjoys and that our German architects have learned much from him. However, by studying Le Corbusier, one can see

what is wrong in his work for German conditions.

The house by Victor Bourgeois is well thought out. There is here no theater of the people but inside it is good, really good! Comfort, consideration of view and of weather conditions. Windows mostly to the south, good positioning of the windows in the room, good proportions for the rooms.

One notices that the houses of Oud are built by an experienced architect who very surely works from his own experience. Here, one can speak of a general, functional architecture. His goal is to create by architectonic means the simplest and most useful possible dwellings.

I am not obliged to single out all the architects whom I have not mentioned, so I will not do so.

It is interesting that Rading has built his house entirely on the basis of the electric lighting circuit. But it is executed in a truly first class way. It sits firmly on small wood boards which project about five centimeters from the roof and wall. It looks splendid. Hopefully, this will stimulate a school of thought; then we would soon have in our dwellings the beautiful overhead systems, which serve to embellish our city image so agreeably.

Hilberseimer's house genuinely affects us. It is fundamental, normal, and without the fantastic—the opposite from the houses by Le Corbusier. Here there are no bath-tubs in the rooms and no columns in front of the windows. The extent to which I treasure this straightforward manner is testified to by the Apossvverlag volume by Hilberseimer, *Grosstadtbauten*, which I edited many years ago. Mies van der Rohe unifies the spirit of the time with format. What is format? A new slogan for architects. Painters have quality, architects format. Format means quality in perception. Hence, a very small thing can have format. At the same time, the house of Mies van der Rohe is large, the largest of the entire settlement. And inside it has enormous effect because of the giant doors which go up to the ceiling. I cannot imagine that one simply goes through these doors—one strides. Great, noble personages stride through these doors, filled with new spirit. Hopefully at least. Yet it could

also turn out as in the Frankfurt Siedlung, where the people arrived with their green plush sofas. It could happen that the inhabitants would turn out to be not so mature and free as their own doors. But let us hope that the house ennobles the people who live in it.

Mart Stam's house is genial and has verve. I am not thinking here of "verve" as something like the roof of a staircase in another house, which should be used in the winter also as a toboggan-run, but I think of "verve" as the sure use of materials for a more unified and convincing effect. Genius is security in working with new things. Do you know the chair by Mart Stam which has only two legs? Why use four legs if two are sufficient? Ella Bergmann Michel water colors hang in Stam's house.

A pumice slab house by May is exhibited. And why not? Frankfurt is easily reached from Stuttgart by water, and a house could easily be made of this material. In any case, the house in Frankfurt is an essential supplement to the Werkbund settlement.

I was among the houses for six hours, having seeped my new summer coat in fresh paint, and so rendered myself indistinguishable from the other visitors. I refused food and drink because there was nothing real and because I had to allow room for the official dinner. I could write volumes on the Siedlung. But I do not do it because I am not obliged to, yet I recommend all to go there. There certainly will not be soon another so convenient an occasion to see something this interesting put together. I also recommend that you follow my example and return in a friend's private car through Wildbad, Herrenalp, Badenbaden, Bruchsal, and so forth; it is a pleasant trip and a good conclusion, although this part of the Black Forest is not the most beautiful. Bruchsal is painted according to the designs of Taut, who also has the brightest house in the settlement. But Mies van der Rohe has calculated correctly that this colorful house stands exactly in the right position for the total image. Otherwise, Bruchsal would be more Rococo than Taut.

Now I will make only one other important suggestion and this is to the Ullstein publishers: I wish that the publisher

would make the decision to publish for the architectural exhibition in Stuttgart a thousand words in Schwabian dialect; this would augment the enjoyment and facilitate the understanding of it.

#### Note

1. Kurt Schwitters, "Stuttgart, 'Die Wohnung'; Werkbundaustellung" ("Stuttgart, 'The Dwelling', Werkbund Exhibition"), *i 10*, no. 10, 1927, pp. 345-348.

## Reviews, Letters and Forum

### On Reyner Banham's *The Architecture of the Well-Tempered Environment*.

Reyner Banham. *The Architecture of the Well-Tempered Environment*. 1969, London, The Architectural Press. 295 pp., \$5.95, paperback.

Kenneth Frampton

*Kenneth Frampton is a Fellow of The Institute for Architecture and Urban Studies and an Associate Professor at Columbia University, New York. He is presently in Europe on a Guggenheim Fellowship working on a study of Purism.*

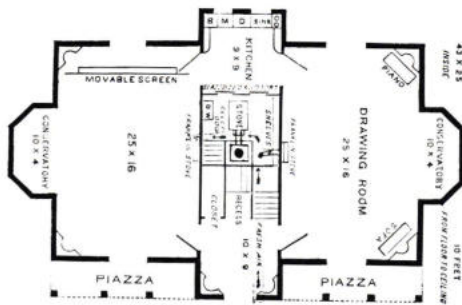

1

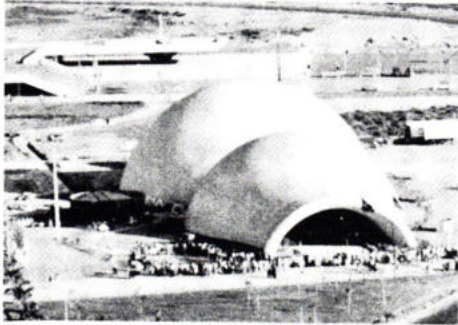

2

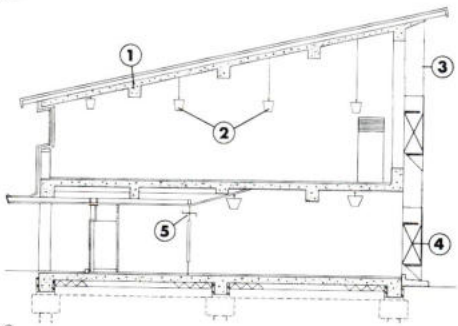

3

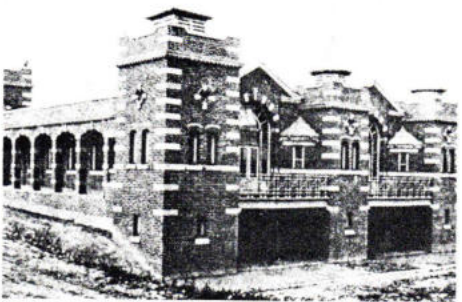

4

This book announces itself at the outset as a polemical history written to redress the imbalance of the received account of modern architecture, which has tended, until now, to give undue importance to the influence of structural innovation—an emphasis which has largely ignored the not-inconsiderable impact of environmental control on both the appearance and performance of built form. But this is only the initial impression, for as the author's introduction makes clear, the overall intent is even more tendentious. Beyond its historical brief, this is a book of heroes and villains—sometimes represented as men, sometimes as buildings, and sometimes as vaguely defined socio-cultural or technical transformations.

As far as heroes are concerned, the author's environmental role of honor would include: first Thomas Edison, for his key development of subdivided electrical distribution; then Willis Carrier, the inventor of full air-conditioning in 1906; and finally, the major architectural hero, Frank Lloyd Wright, for the undeniable genius of his environmental sensibility. Other figures of virtue follow, but at a slight distance: among them, the mid-Western mother of the "well-tempered" open plan, Catherine Beecher, for her pioneering environmental work, most particularly for her project the American Woman's Home of 1869; Buckminster Fuller mentioned only in passing but lauded elsewhere for his lightweight dymaxion version of the same; and certainly, at almost the same level, Victor Lundy, that pioneer of the inflatable, for his pneumatic mobile theater of 1959. On the other side, the "villains" are somewhat less specifically established. Certain *bêtes noires*—or should one say *bêtes blanches*—of the Modern Movement are singled out by name: Gropius, Rietveld, Le Corbusier, etc., but, generally, the major villains are seen as collective classes and forces rather than as individuals. Other villains include the architectural profession as a whole for its elitist resistance to the assimilation of advanced environmental

technique, and the so-called International Style, for its notorious frigidity, visual glare, and hardness of acoustical tone.

Against this, the author reiterates his now familiar praise for the necessary virtues of pragmatic technical invention—the back-room boy as generic hero (Bernard Shaw's "new man" in updated dress?). All this would be acceptable were it not for the elliptical logic that attends its presentation. For while the scope of this work is correctly extended beyond the bounds of historical description, the implicit case of Banham's polemic seems to rest on the assertion that were we once to free ourselves from the atavism of aesthetic symbolization, modern technique would spontaneously bring about harmony, if not among ourselves, then certainly within our environment—including, presumably, that of nature.

Such an assertion is Benthamite and utilitarian to the core: the greatest happiness of the greatest number seen in terms of rationalizing human welfare through technique; an anti-art polemic that welcomes the determination of "culture" through consensus; the realization of human destiny not through politics but through the processes of the manipulated market. Disregarding the post-1945 oil and automobile lobby for the wholesale federal subvention of the freeway, and FHA veteran's mortgage provisions that favored, above all other forms, the freestanding suburban house, the author presents the subsequent proliferation of the ranch-burger as the popular assimilation of Wright's West Coast domestic style.

"For this situation, the adoption of some aspects of the Wright/California idiom as the international norm for hotels and motels is doubtless largely responsible, even if the idiom has been thinned out till little remains but woodgraining and wide horizontal shelves and rough-textured walls. But this idiom has genuine virtues—it is visually undemanding, acous-

1 *The American Woman's Home, project.*  
Catherine Beecher, architect, 1869.  
Ground floor plan.

2 *United States Atomic Energy*  
*Commission Portable Theater.* Victor  
Lundy and Walter Bird, architects, 1959.

3 *St. George's School, Wallasey,*  
*Cheshire.* Emslie Morgan, architect,  
1961. Diagrammatic section of  
environmental provisions: 1) Insulated

roof structure, 2) Light fittings, 3) Double  
skin solar wall, 4) Adjustable ventilating  
windows, 5) Ventilating windows at rear  
of classroom.

4 *Royal Victoria Hospital, Belfast.*  
Henman and Cooper, architects, 1903.  
Exposed end of ward block as originally  
completed.

tically quiet, thermally comfortable because its vegetable-fibre surfaces are quick to warm. Furthermore, these surfaces and forms seemed to settle well with central heating, electric lighting or (later) air-conditioning, and they had so settled long before the style began to spread beyond the Chicago and California suburbs that gave them birth . . . the external styling of such houses had already become irrelevant even in the years before the two decades of the 'suburban period house' . . . the usefulness and applicability of the interest in human engineering lay, partly, in the fact that it had been detached, effectively, from any architectural style as normally conceived."

It had, in fact, become processal building as it is normally conceived; that is, a highly prevalent pattern of land settlement simulating a vernacular—a mode of construction that usually does not require, and even more rarely receives, the intervention of an architect. To welcome this admass future as a millennial destiny was to anticipate, with the first edition, in 1969, that "instant utopia of Los Angeles" to be shortly celebrated by Banham and others as the great reconciling triumph of the pluralist will. But just how pluralist was it? One may entertain certain doubts since at current suburban densities, with the average suburban home costing around \$40,000, at least well over half of the American populace was and still is excluded from participation. And this fact is forcibly brought home by the ever-increasing share of the annual housing market now going to the trailer industry—a small element of bad tempered hardware that Banham curiously fails to mention.

But even if it is the great pluralist will, what is the circumvented architect supposed to do about it? Should he, in some final contradictory gesture emulate, as suggested in *Learning from Las Vegas*, the so-called spontaneous culture of popular form? And what would that be, spontane-

ous culture or degenerate elitism? The common lack of an adequate answer to these questions seems to suggest that Las Vegas doesn't need the architectural profession. One might venture to add, as Banham virtually does, that it is "well tempered" enough without it.

Yet the cultural gloss that Banham compulsively insists on laying over this central polemic only serves to confuse the issue further, for, despite his allegiance to populism, a certain retrogressive taste for elite culture remains. Like a scar on the mind, the architectural historian's deformation endures, and we, the ever-recalcitrant profession, remain to be instructed as to the true and false traditions of our century. Thus the Dessau Bauhaus and all its works is to be roundly castigated for neglecting the consumer, while Paul Scheerbart is to be honored for the technical perspicacity of his vision and his passionate commitment to color. On the other hand, Le Corbusier is to be derided for his unquestionably naive anticipation of a universal *respiration exacte*—never mind that the current universal availability of air-conditioning has achieved exactly that. At the same time, one has to note that an early love dies hard and that the Italian Futurists who feature so prominently in *Theory and Design in the First Machine Age* are, however misguided, still to be respected for their unbridled technological enthusiasm.

A method of evaluation more prejudicial than this would be hard to imagine, for while one should unquestionably challenge the psychological and environmental shortcomings of the International Style, there is precious little ground for accusing its apologists of special pleading when one indulges in a comparable line of reasoning. For clearly, if one takes solar heat gain seriously, along with the issue of desirable criteria for thermal and acoustical comfort (let alone the question of achieving a suitable psychological ambience), then the crystal vision of Scheerbart, with its steel

and glass fiber interior, and the Futurist *Città Nuova* would have proven by now as unacceptable to any popular notion of comfort as anything perpetrated by the *neue Sachlichkeit*. In any event, we may rest assured that Scheerbart's greenhouses would have certainly been as susceptible to the dreaded "greenhouse effect"—i.e., to the excessive accumulation of solar heat—as anything realized by Le Corbusier.

Here once again, we are enmeshed in the same polemic; while technological romanticism is inherently good, classical humanism is intrinsically bad. The noble savage, the poet, the man-in-the-street, the boffin, the Yankee tinker, the Las Vegas sign designer, the admass journalist, and the racketeer are all ultimately creatures of virtue; the architect, unless he masquerades as technocrat or as a technological romantic, is inevitably the agent of repression. Yet the ease with which Banham proclaims the self-evident virtues of air-conditioning must surely today give even the most hardened progressive a certain pause; for all considered, the author displays insufficient concern for the well-tempered environment as it must eventually affect man's rapport with nature. A brief aside to the "ecological" design method of Ralph Knowles without once acknowledging that his work is largely opposed to the received culture of "air-conditioning," and a laudatory page or two devoted to the late Emslie Morgan's eccentric attempt at solar conservation—the clumsy St. George's School, built at Wallasey, Cheshire, in 1961—are hardly enough to dispose of the subject adequately, particularly in a context where the optimum use of technique is otherwise acclaimed as the epitome of progress.

The confusion underlying all this is, perhaps, best exemplified by Banham's appraisal of the evolution of the design of the United Nation's building in New York, where, while conceding that Le Corbusier in his initial *parti* did not intend a simplistic glass slab, Banham writes: "The glazed

88 walls to Le Corbusier's well-documented wrath were not protected by *brise soleil* and they faced almost due east and west . . . Carrier and Wallace K. Harrison as executant architect, addressed themselves to the environmental consequences of this orientation with the aid of an air-conditioning system that was a true son of the PSFS." The reference here is to the second centrally air-conditioned office building in the United States, the Philadelphia Savings Fund Society building, completed in 1932 to the designs of Howe and Lescaze, with Carrier acting as the environmental engineer. Needless to say, the reader hardly has to ask who is the hero of this piece of historical comparison. Certainly, it is not Le Corbusier but Carrier, with Harrison a close second, even though it was the latter who had stubbornly refused to heed the advice of Le Corbusier with regard to shielding the elevations against the sun. The consequent extra consumption of energy may not have been in the best interests of the United Nations, but one may allow that it suited the interests of the utility companies in a pre-crisis era.

The persistence of this polemic compels one to question the status of this work as history. In this respect, it must be admitted, at the outset, that Banham has performed an important service to the history of building technology in entering into the annals the name of Willis Carrier. This is a prime step toward redressing the imbalance of architectural history, inasmuch as this history is inseparable from the development of technique. There are too, of course, passages of Banham at his most perceptive: his realization that the late nineteenth-century revival of the inglenook by Wright and Voysey was possible only "in an epoch that disposed of piped central heating," and his understanding that Edison dramatically entered an arena where, only thirty years before, the average level of domestic illumination had been hardly above that of the Middle Ages. Finally, there is his unique appraisal of the Robie House, that

acme of Wright's first period, concerning which Banham concludes: "Nothing he did in the rest of his long career quite matched the inventiveness and total control over every aspect of the building that characterizes the Prairie Houses of 1889-1910."

A positive account must also be rendered of the brilliant piece of environmental archeology at the very core of this book concerning the plenum-ventilated and partially air-conditioned Royal Victoria Hospital, Belfast, completed in 1903, and, as far as I know, hitherto unknown. All of this is vintage Banham, comparable in every respect to the seminal scholarship of *Theory and Design in the First Machine Age* and to the interpretative sensitivity of *The New Brutalism*. But such instances are relatively few, and the rest of the text oscillates uneasily between polemic, exegesis, and fact—this last being the most curious element of all, not only for the facts included but also for those that are inexplicably omitted.

The facts as they are assembled here leave one with the uncomfortable suspicion that one has only half the story. For instance, by what means exactly did New York transform itself to district steam-heating in the early 1880s? Or who was William Key, that benighted Englishman who invented an early plenum system and then passed on his way without meriting so much as an entry in the index? And who was that unknown Berlin architect, J. R. Davidson, who exercised such influence in California in the late twenties? This "unconsummated" name dropping reaches, from time to time, embarrassing proportions and something similar has to be said about the lack of adequate illustrations. It is impossible to understand, for example, why the Holborn Viaduct, which happens, so we are told, to be the site of the first electrical domestic mains and street light installation in the world, does not even merit the inclusion of a sectional drawing. In the midst of so much polemic one really wonders whether the pictorial evidence might not

have been prudently expanded at the expense of the text. When it comes to the omissions, one ponders in vain as to why certain rather well-known examples were omitted. There is no mention of John Claudius Loudon, whose pioneering contributions were surely as crucial as those of Paxton and Catherine Beecher; no mention of Adler and Sullivan, whose environmental achievements in the Auditorium Building, Chicago, were far from negligible and who were, in addition, the prime mentors of Wright; nothing of the Gaiety Theater of the mid-nineteenth century, which was surely as advanced for its day as Archigram's Queen Elizabeth Hall; and why is there no reference to the Chicago Tunnel Company, that cold tubular infrastructure which was exploited as a secondary benefit to provide cooled air to the office buildings of the Chicago Loop? And why nothing of the vacuum cleaning system that was integrated into the Robie House? Are we to conclude of this last that it was installed after the fact? Or is it that its architectural impact was insignificant?

All these omissions would be of little consequence if *The Architecture of the Well-Tempered Environment* had been offered as an *esquisse*, as was Enzo Fratelli's *Architektur und Komfort* of 1967 by which, incidentally, it was probably influenced. But far from being presented as a sketch, it is presented as an aggressive challenge to architects and historians alike, and above all to one historian in particular—the late Sigfried Giedion whose *Mechanization Takes Command* of 1948 haunts the pages of this work like a ghost; from the critical reservations announced in the introduction to the begrudging acknowledgments given in the short bibliography at the end, where Banham brings himself to concede that "in spite of such spectacular shortcomings as a total failure to attack the history of electric lighting [it] still contains a mass of useful if ill-ordered information. . . ." It is a sobering irony, to say the least, that when it comes to spectacular lacunae and chaotic information, Banham's book is in a class of

its own, with which Giedion at his worst would be hard pressed to compete.

The unavoidable question remains, then, not why this book was written, but rather why it entered the public realm in this form—for that Banham could have written an incisive study of this subject is beyond dispute. Perhaps the answer to this question lies not so much with the author as with the context in which, until very recently, he lived and worked. For prior to the recent depression, the British uncritical enthusiasm for the adoption of advanced admass technique irrespective of cost in both monetary and human terms attained the proportions of Benthamite hysteria—witness, to take but one example, the production of the Concorde and the lack of British participation in the more modest but more immediately applicable European air bus. Are we in the presence here of a collectively disoriented national identity that, still nostalgic for its vanished imperium, lies suspended in mid-Atlantic; a consciousness that belongs neither to Europe nor to the New World? This consciousness still depends on America, not only for its economic survival but also for the vicarious fulfillment of its frustrated reformist dreams and for the reflected radiance of its vanquished power. It looks to America for the development of a technology of which it was once the sole proprietor. Mesmerized by the so-called Pax Americana, it has difficulty in confronting the contradictions of “progress.” Instead it accepts the sovereignty of a dominant culture, whose legitimacy is assured by its *apparent* popularity.

Unavoidably compromised by this climate, the English intellectual is faced with two choices. He may either more or less continue to rationalize the system, or alternatively he may begin to develop a critical theory of the built environment. For, in the end, a “technological *a priori* is a political *a priori*,” however far removed it may seem to be from the field of immediate power.

And of this Banham is more than half aware, as he hints in the many asides in his text, and most particularly where he refers half derisively to the British use of “full cool” air-conditioning as a device for the interrogation of Arab detainees. Notwithstanding the force of pluralist consensus, technique has finally to relate to an end and this end may be either another means, or another abstraction, or else an instrument for the “liberation” of men. This is an issue that is to be faced, for rationalization, however subtle, eventually tends toward a false consciousness of which *The Architecture of the Well-Tempered Environment* is an example. No one surely wishes to return to medieval lighting levels, but to rationalize modern technique without discrimination is to rationalize consumerism and to produce a book that is largely a proof of the selfsame principle.

#### Figure Credits

1–4 Reprinted from Reyner Banham, *The Architecture of the Well-tempered Environment* (London: The Architectural Press, 1969).

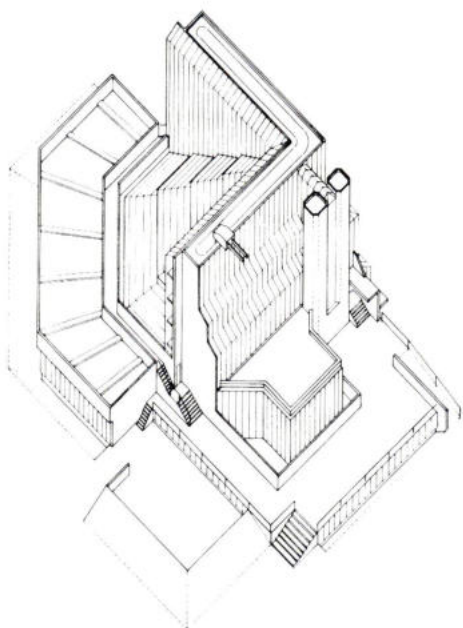

Cambridge University History Faculty Building. James Stirling, architect, 1964.

### On James Stirling: Buildings and Projects 1950–1974.

*James Stirling: Buildings and Projects 1950–1974.*  
1975, New York, Oxford University Press. 184 pp., \$30.00.

Rafael Moneo

The book *James Stirling, Buildings and Projects 1950–1974* has long been needed. For in spite of the fact that much of Stirling's work has already been published, this effort to bring together all his projects, to collect all his lectures and articles, to establish a proper chronology, and to formulate a precise "curriculum" will certainly be valued in the future by all who are attracted to his work. It will also greatly facilitate future studies. One does miss a bibliography however—although it would be difficult to assemble one given the extent and diversity of the published material—for it would have provided a definitive realization of the objectives apparently envisioned by this book.

But the book is concise and correct and avoids all rhetoric. It is invested with a sense of order that is absolutely essential for managing the accumulated graphic material, whether sketches or photographs, which are of excellent quality. It can be said that Leon Krier and Stirling himself have taken as an almost obligatory point of departure for their production the style set by Le Corbusier for publishing his own work, and later used by Alvar Aalto, José Sert, Alfred Roth, and many others, until it has almost become a canon for modern books of architecture. The book deliberately avoids *studying* Stirling's work, seeking rather just to present together the collected work of an architect over a period of twenty-five years. Even the introductory note by John Jacobus preserves such neutrality that it is immediately removed from the field of interpretation, although there are in it some hints for beginning a biographical study, an attitude which I believe is a necessary condition for undertaking a more thorough investigation of his work.

Nonetheless, the value of the book lies precisely in the fact that Stirling's work is shown to us in its totality—we are forced to think of it in terms of "complete works"—and therefore it is offered as continuous reading over time, which must inevitably

*Rafael Moneo is presently teaching at The Cooper Union School of Architecture and at The Institute for Architecture and Urban Studies, New York.*

result in interpretation and judgment. Since Stirling takes the risk of bringing out a "complete works," and accepts the prominent place that he has in the recent history of architecture, it therefore seems fair to pass judgment on it from this perspective. If one compares, for example, Richard Meier's recent book about his own work, one sees Meier's as a book of work in progress; it lacks the sense of the definitive and authorized document provided by Stirling's.

Hence, for me, the most surprising aspect of the book is that instead of appearing to be the strict history of the career of a single architect, the book, when seen in its totality, takes on the quality of a more general history. This is because it is a perhaps unique quality of Stirling's work that it can be used as a continuously validating illustration and documentation of the development of the course of architecture in the last twenty-five years. We are accustomed to see Stirling's work when it appears in architecture magazines as something momentary and isolated—a building, or a project—and we are led to believe that it is his strong personality which gives it its continuity. In some way a myth of a legendary Stirling, overvaluing his intuition and his role as a self-made architect, has been created. But now, by virtue of the panoramic nature of this book, it is rather the contribution of the work to the knowledge of the history of recent architecture, which one discovers in its unfolding continuity, that one may cite. It is, in fact, the history of the architecture of these last twenty-five years which can be called the real protagonist of the work. We are in this sense confronted more with the history of recent modern architecture than with Stirling's own career in particular. This is something that cannot be said of the work of all architects. For example, when we compare other architects who have also presented us with their "complete works"—Le Corbusier, Aalto, and Kahn for example—we may see a personal evolution, but we can never trace through it the

history of architecture during the years in which their careers developed. Stirling, however, in spite of his strong personality, has always been an architect sensitive to the problems constantly presented by the discipline, either perceiving them himself or incorporating them into his work. In this change of focus lies the precise value of the book. Let us see why.

The problems of the fifties are evident in Stirling's work and they reflect all the complexity of English architecture in these years. From the perspective of the seventies, the English fifties acquire a special interest, for during this period the first attack against the way the Modern Movement was being interpreted was produced, an attack launched primarily by the circle around the Smithsons. Indeed something of the Smithsonian and Team X influence may be felt throughout Stirling's career to date. It is present even in the recent housing for Runcorn whose organization reflects the new urban complexity initiated by the Smithsons in the fifties, together with their idea of housing as "clustered structure." The first accomplished work reproduced in the book, the table in Stirling's bed-sitter (1951), is a splendid as well as brief summary of all that can be understood as modern in the early fifties. The small house projects such as the Core and Crosswall House (1951) and the later Sheffield University competition scheme (1953), marked by their search to return to the rigor recognizable in Le Corbusier's work and the language of architecture, reflect the influence of Wittkower and Colin Rowe. Woolton House (1954) and the proposal for a village settlement (1955) summarize the aims of Team X, searching for a more complex way of developing the design of urban spaces and identifying in vernacular architecture the authentic roots of the discipline. Ham Common (1955) and the works around it (House on the Isle of Wight [1956], Preston Housing [1957]) show the attempt to reach a new modern language through the process of the ethical compromise with mate-

rials and structure that produced "Brutalism." Stirling's work can be seen as one of the most accurately characterized examples of these trends in the fifties, and Ham Common, in particular, demonstrates the value of Stirling in the architectural scene, showing from the beginning of his career his influence as a "form-giver," for which he has always been given credit.

Toward the end of the decade of the fifties, Stirling produced two projects—Selwyn College in Cambridge and the Engineering Building in Leicester—which undoubtedly mark the highest point in English post-war architecture; after this Stirling freed himself from groups and tendencies and his work reached its maturity. It was no accident that Leicester, designed at the end of a period of intense activity in English architecture, marks the point of Stirling's emergence to prominence. After this point, English architecture languished, on the one hand, in the prolongation of Brutalism to its inevitable conversion into style, and on the other, in the technical exaggerations of Archigram. Stirling who, as we have seen, was *between* the protagonists in the fifties, was from this time on an outsider in his own country.

Despite this change, however, his work from the early sixties reflects and testifies to the different approaches taken in those years, both at home and abroad, to the deadlock established by the orthodoxy of the Modern Movement. Thus, we may detect such a tendency in a project like the home for the aged in Blackheath (1960); the impact of Kahn appears in many details in Selwyn College (1959) and Leicester (1959–63), but more especially in a project like the Dorman Long Headquarters (1965) and later in the proposals for the Siemens AG complex (1969); and, of course, a tribute to Archigram is paid in buildings such as the Faculty of History in Cambridge (1964).

This continuous attention of Stirling to the march of history is also characteristic of his

more recent works, in which we can equally find elements that illustrate the discussions in architecture developed over the last ten years: attitudes from the Italian *Tendenza*, elements from the Venturis, details and quotations from the new American rationalists, and compositions reflecting the impact of the recent ideas of collage. In effect, projects such as Runcorn (1967) cannot be explained without recognizing the influence of studies by critics and researchers in architecture, for the most part Italians, who have made the study of the city and its morphological problems the basis for their work. The Olivetti Training School (1969) and the St. Andrews Arts Center, and the details for Derby and the Lima project, break down the formal coherence which had been Stirling's evident preference in projects such as Leicester or Queen's College, and now transform it with extraordinary freedom by means of the coupling of different stylistic elements which would have been difficult to conceive without Venturi. In Milton Keynes Olivetti Headquarters we find tendencies similar to those exhibited by certain American architects at the same time through their re-discovery of Le Corbusier. Finally, the idea of the composition through collage, so carefully explained by Tafuri when speaking of Piranesi and by Colin Rowe when using it as an instrument for the construction of the city, appears strongly and definitively in the projects for Düsseldorf and Cologne, although it is possible to discern this idea in some earlier schemes such as Derby and Milton Keynes.

Stirling today, as always, is the reflection of the present itself; we can use him to exemplify many movements in recent architecture. From this point of view, Stirling is the mirror in which is reflected the history of recent architecture, a mirror capable of condensing this history into the unified visage of a single face.

But a group of works—Selwyn College, Leicester, Queen's College, St. Andrews—resists any possible attempt at classifica-

92 tion, for the only way of doing so would be to introduce a singular chapter in the history of modern architecture, a chapter dedicated to and about James Stirling, who will cease to be the reflection of history and chronicler of it, to become himself the protagonist of history. Writing this chapter will not be an easy task, because Stirling's architectural motivations and tools are not always easily identifiable. Stirling is more subtle, sophisticated, and complex than the false appearance of "nowness" and freshness seems to indicate. However, from now on, criticism on Stirling will have the invaluable aid of his book, which as we have seen, imposes the obligation to clarify the sense of a work that, seen from the perspective of "complete works," loses the possibility of being interpreted as a personal saga to fall into the not always calm waters of history.

Figure Credit

Reprinted from *James Stirling: Buildings and Projects 1950-1974* (New York: Oxford University Press, 1975).

Errata

*The Editors of Oppositions profoundly regret that Marlène Barsoum was not attributed for her work on the production of Oppositions 6.*

To the Editors:

Recently I received the following letter from a friend. Because of its topical nature, I think that you might find it interesting for *Oppositions*. Sincerely,  
Alan Chimacoff  
Princeton, New Jersey

Dear Alan,

After quite a long journey I am finally writing. I am relieved to be home at long last. My travels led me through heavenly mansions, several white cathedrals, and I bathed with Caracalla. I attended a grand *parti*, so to speak, at Vaux le Vicomte and dined in splendor just outside Lyon. In Tokyo the Emperor was gracious and the hotel was pleasant. As I descended into New York, the buildings appeared a bit too small and a bit too close together. The George Washington Bridge shone with splendor.

The real purpose of this letter, though, is to describe the most interesting, if also confusing, time I spent in New York, and to ask if this is really the way it is.

Knowing where my interests lay, a friend offered to bring me up to date. He suggested that we take a tour to see some recent works of architectural merit: "the objects of current polemics and argument among the cognoscenti," he said. That was fine with me and I felt I couldn't have a more appropriate guide. My friend had just been appointed associate editor of an architecture magazine. Acting on his advice, I shed my porkpie hat, shaved my beard, exchanged my circular blackrimmed spectacles for a pair made of wire and we were off.

The buildings we were to see were located about a hundred and sixty kilometers east of New York City, out on a very long island. As we drove my

friend described the "current arguments among the cognoscenti." He spoke at length about "white and gray," about American ideals and history and adaptations of European traditions, about post-modernism and, believe me, I was confused.

The first building we stopped at was described by my friend as being "white." "It certainly is," I said. The building was all white. Painted. Small boards, painted all white. Smooth and white, inside and out.

"This is pretty obvious stuff," I said. "But I don't understand why there is such an issue made," I said, referring to our previous discussion in the car.

"I'm not sure you understand," my friend replied. "White refers to stereometric forms, smooth surfaces, volumetric voids, planar but incised openings; not only to color."

"Well, it sure is planar and all that," I replied, "but if I understood what you said about stereometric forms then I'm confused because this one is two, connected together with a bridge, and the big one appears to be a cube but one entire corner is curved and another is eaten away by a stair."

"You're pretty naive," my friend said. "This is a white building. By the whitest of the whites."

"It is very clean," I answered.

We returned to the car and as we drove on my friend suggested that perhaps I'd catch on after we'd seen the next white house.

"White?" I asked when we stopped again. "But this one is gray, almost silver," I exclaimed.

"No, no; you've got the metaphor all wrong. Gray and silver represent the other sides," my friend insisted.

"Metaphor? What metaphor? This building is made of small boards left to the weather. It's gray, almost silver, and the boards inside look brown. I'll admit, though, that this one seems to be

stereometric all right. The other sides of what?" I asked.

"The other sides of the argument that I told you about. I wonder if you'll ever understand."

And so we drove again.

"Now this is a 'gray' building," my friend exclaimed when we stopped again. I found myself in front of a building much different in outward appearance and decoration from the others we had seen, which I must confess actually *did* seem to have a certain kinship between them, but still I did not understand.

"Gray?" I asked. "There is nothing gray about this place. The outside is made of dark brown shingles. In fact, they're almost black. And the inside is all white, just like the first house we saw."

"You're being too literal," my friend said. "You're overlooking questions of style and history. This argument I've been talking about is based upon attitudes about history. It's much more profound than the surface characteristics which you've been observing and commenting about."

He tried to explain further.

"You see, the 'whites' are reviving the heroic period of the twenties."

"Heroic? In 1520?" I asked.

"No, the 1920s. You know, Corbu, Villa Garches, Villa Savoye. . . ."

"Ah, yes. Corbu, Garches, Savoye. White. White? What about the pinks and baby blues? And what about the grays?"

"Well," my friend continued, "the grays believe that they are more responsible to history and more responsive to the needs of the present."

"They do?" I asked.

"Yes. You see, they feel that they draw their references from further back into history. The Shingle style. Pre-modern architecture and the transition to it. Picturesque English country houses. Edwin Lutyens. And the grays also

consider their work more American than the whites."

"Now, wait just a minute," I said emphatically. "I think this is getting just a little bit out of hand, not to mention illogical. Which is it? Pre-modern or post-modern? How does being more American stem from Lutyens? And does legitimacy derive from how far into the past one delves for inspiration? Wouldn't that make Lou Kahn more legitimate than the whole lot? After all, he is the modernest Roman of them all, you know."

"Lou Kahn doesn't enter into this argument."

I continued. "I once read an article which compared the Villa Garches to a work by Palladio. In fact, Palladio influenced a lot of the English country houses you were talking about as being inspirational to the grays. Now tell me; doesn't the relation between Palladio and the Villa Garches seem to lend greater historical credibility to the whites? After all, the Renaissance is older than the Schinkel style."

"I didn't say Schinkel style. I said Shingle style," my friend said a bit indignantly.

"Oh my! Then the time gap is greater still, isn't it?" My friend was perplexed, his brow furrowed. He became silent, almost sullen.

"What about the roofs?" I asked, breaking the silence. "The whites, as you call them, seem to make flat roofs while the grays' are pitched. Is that important?"

"At last," said my friend with spirit restored, "you are catching on. All the manifesto buildings had flat roofs. But not so with the Shingle style."

"Manifesto? You mean Karl Marx was an architect too? Was he white or gray?" I asked.

"I don't think we should get into that," my friend declared.

By this time we had seen many more buildings, some white, some gray. We

had passed through a nasty area which my friend called the "devil's sand pit," a large area near the ocean between the dunes and the highway. There were row upon row of small houses. But there were no gardens, no fountains, and it was a spaceless milieu. Although my friend said that most of these were uninteresting and not worthy of the argument, I said that I felt that many of these were equal to some that he had shown me. He said that I had eyes which do not see.

I was pondering this as we rounded a bend and then I was dumbfounded to see, on the right hand side, sitting alongside the road, an enormous plaster duck, about four meters high, with a doorway into his breast just where the wishbone ought to be. To the left of the doorway into the duck's belly was printed, "The Big Duck; trade mark Reg. U.S. Patent Off."

"This will interest you," said my friend, "it's called the big duck."

"So I see," I replied.

"It's a cult object in a reverse sort of way," he said.

"A cult object? What goes on inside?" I asked.

"Oh, you can buy ducks," he said, "and chickens and maybe also turkeys and geese."

My friend then proceeded to describe to me how this big plaster duck was also significant. He told me about the cult of the ordinary and about ducks versus decorated sheds; how in the terminology of the cultists of the ordinary that some of the buildings we had seen were just like the duck—especially the white buildings. In the process he quoted something from Ruskin or Pugin about it being okay to decorate buildings but not okay to build decoration. Decorated sheds, I was told, were all the rage within the cult of the ordinary and that in the end the ugly and ordinary were probably the wave of the future in

94 high-style modern architecture.

"Ducks versus decorated sheds," I mused. "Why would anyone want to decorate a duck's shed? Sounds like diversion for the idle rich," I said. "Don't be so cute," my friend said. "Let's go inside."

When we entered this duck building I discovered that the inside had nothing to do with the outside. The ceiling was flat; the walls were flat; the floor was flat; and at one end of this ordinary little room was a counter and a cash register alongside a refrigerated poultry display case inside which were, indeed, ducks, chickens, turkeys, and geese—all for sale.

Insight flashed and I exclaimed, "Finally, it's clear! This little room in here is just like a little shed only the outside has been decorated up to look like a duck. So a duck and a decorated shed are precisely the same, aren't they? That's it, isn't it? Ducks versus decorated sheds?" "Oh, no, no, that's not it at all." My friend seemed crestfallen.

"May I help you?" asked the woman behind the counter. "How much do the ducks cost?" I asked. "Ninety-nine a pound," was the reply. "And about how much do they weigh?" "Four'n-a-half, maybe five pounds." "How about the chickens?" I asked. "Seventy-nine." I couldn't decide. "I can't decide," I said, "whether I'd prefer duck or chicken." "Listen, Bud," she responded, "this doesn't have to be an either/or proposition. Wyncha take a duck *and* a chicken? Take both . . . and . . . maybe you'd also like a small goose; they're only a buck-ten a pound." "But don't you think that it would be a bit extravagant to buy both duck and chicken and goose too?" I asked. "Nah. Live a little. Why be exclusive? Be

inclusive. Try 'em all."

"I wasn't really thinking about being inclusive or exclusive. I just think that it might be excessive . . . I couldn't eat them all and so I'd have to freeze some and then they'd lose the quality of their freshness."

"Maybe you should give a dinner party," the woman answered, "then everything would be fresh."

"I don't know," I replied. "I think that I ought to buy either one or the other and save some money. This inclusiveness could get expensive."

"Your choice," she said.

I asked what was best.

"Well, they're all good but the ducks are the best. If the goose were best, y'know, this place would be called the big goose and this humble little shed would be decorated with a big plaster goose outside and not a duck."

"Okay," I said, "let me have a couple of ducks."

I paid and my friend and I returned to the car.

"You know," I said to him, "that lady was pretty pushy with that both-and, inclusive business. I'm still not sure I understand the essence of this cult of the ordinary movement. Explain it further. Is there a leader? There must be. What is the leader like?"

My friend thought for a minute. "It's a long story," he said, "but there is a leader." He paused again and said, "I guess the leader is pretty much like the lady inside the duck."

Several days after we returned to New York, my friend called me excitedly. Bubbling over he invited me to attend a new museum showing with him. "You'll love it," he said, "it's the Beaux Arts! Greatest thing since the Bauhaus." "That shouldn't be difficult," I said, "but wasn't the Beaux Arts thrown out by modern architecture?"

"Yes, of course it was," my friend answered impatiently, "but it's time to reexamine basic values. We mustn't throw out the baby with the bath. Besides, everyone in New York is saying that modern architecture is dead."

"They are?" I asked. "It is? Is it really dead? But just the other day you were saying. . . ."

"Yes, of course it's dead. Nobody ever knew what to do between those pilotis anyway. . . ."

"What killed it?" I asked. My friend's transformation confused me even more than his description of architectural deep structure.

"Obviously," he said, "it killed itself."

With warmest regards,

Al Carciofi

To the Editors:

In *Oppositions 6* you printed an editorial by Peter Eisenman, titled "Post-Functionalism." In this editorial, Eisenman gives us the fullest statement yet of the theory which underlies his architecture. According to this theory, the rules that govern architecture are independent of the connection between physical form and activities or functions. The shapes and configurations which are represented in specific buildings are best understood as the working out of principles that operate at the level of form *sui generis*. Eisenman believes that the task of architectural theory is to identify the rules, which are only adumbrated in the built object. To help elucidate the principles, he suggests that we rely on contemporary modes of thought in other disciplines that also have claimed that the phenomena they investigate have an autonomous structure. Eisenman refers to semiotics in its approach to language and structuralist anthropology in its analysis of literature. As a means of confirming the appropriateness of his definition of architecture as the evolution of form itself, he invokes the history of so-called

modernist painting, music, poetry, and prose. These arts too, he says, have fostered a new sensibility by ignoring their social purpose and the external reality which, at one time, they sought to represent and symbolize.

This is an interesting position. And Eisenman states it forcefully and with great precision. But there are several questions I would like to raise about his argument.

I wonder why Eisenman chooses the label "post-functionalism" to identify his position. This term was fashionable a half century ago, when it was used to classify architects, who, although they maintained a commitment to the esthetic doctrines of the International Style, nevertheless rejected its sources in functionalism. I can't believe that Eisenman really wants his view of architecture to be equated with the esthetic doctrine of the International Style. His ideas are much more sophisticated and are based on theories drawn from disciplines that had barely emerged by the 1920s.

It is not clear whether Eisenman is offering us a theory *for* architecture or a theory *of* architecture. A theory *for* architecture is a conceptual framework that may be useful to architects when they make choices among the various elements which influence the character of a designed object. In emphasizing the formal properties of buildings and suggesting rules to regulate the exploration of form, the doctrine of post-functionalism, as he outlines it, strikes me as quite reasonable, once the premises of the theory are understood and accepted.

A theory *of* architecture is a model for organizing the variables that explain the character of a completed object as it exists in a specific setting at a particular time. Looked at from this perspective, post-functionalism has doubtful validity.

How is it possible to deny that buildings have use-value, to adopt the phraseology of the Marxist estheticians? Is it really possible to conceive of a built object, which is a product of human effort and skill, without paying heed to its form and its functions? Another editor of *Oppositions*, Kenneth Frampton, pointed this out in an editorial in *Oppositions 4* when he said that "the building task . . . remains fatally situated at that phenomenological interface between the infrastructural and the superstructural realms of human production."

In raising a question about the intentions of Eisenman's theory, I do not mean to imply that theories *for* architecture can be substituted for theories *of* architecture and vice versa. On the contrary, each type of theory has a different role to play in architectural *praxis*. It was Norberg-Schulz's failure to acknowledge the distinction between the two kinds of theory that was largely responsible for the disappointment we all felt with his critical work.

Eisenman has done a remarkable job of making the bridge between architecture and the general intellectual culture. This achievement is a major move in raising the level of architectural discourse and reducing the alienation of the architectural culture from other disciplines. But two aspects of his use of semiotics puzzle me. Why does he confine his semiological analysis to the formal properties of buildings? And doing so, why then does he suggest that it justifies an architectural theory that replaces the dialectic between form and function with a dialectic that is concerned only with the evolution of form? Isn't it true that an analysis in terms of syntactical relations applies equally well to the study of building functions? If so, and if one believes that the models of structural analysis and semiotics should guide further theoretical work, why can't we have a theory which deals with the

syntactical structures of form and function simultaneously? A duplex theory would have the great virtue that it locates the architectural phenomenon in an ontological realm which, to paraphrase Frampton, straddles culture *and* society.

Eisenman's infatuation with structuralist thought and with modernist art probably accounts for his insistence that architectural objects should be viewed as "ideas independent of man." This belief may be responsible not only for his lack of interest in the syntax of functions, but also for his lack of concern for the semantic dimension. To the extent that Eisenman is reacting to the loose way in which attributions of symbolic content and meaning are thrust upon architecture by every museum lecturer and teacher of art appreciation, this austere view of the relation of built objects to their cultural settings is perhaps understandable.

However, if the aim is to develop a theory which can interpret the vulnerable situation of architecture in industrial society, then the idea of an architecture conceived without reference to function makes no sense. The semantic content of architecture derives not from the nature of architecture so much as it reflects the inherent psychology of man. It is the consciousness of men and women which is ultimately the source of signification in architecture. We cannot, therefore, get rid of meaning unless we are ready to dispense with human culture. Surely Eisenman does not advocate mass genocide as a way of preserving architecture? Why, then, does he exclude the semantic dimension in the discussion of post-functionalism? Is this further evidence that his theory is not a theory *of* architecture but a theory *for* design?

Why must architecture deny its existential condition as a discipline

96 concerned with an object that has both use-value and, at the same time, belongs to the world of art? Why is a contemporary theory unable to attend to the dialectic of form and function? Eisenman answers that functionalism is a species of positivism, and positive philosophy is an anachronism. We are informed that a crucial shift occurred in the nineteenth century in which a new consciousness replaced humanism: but that architecture did not participate in or understand the fundamental aspects of that change. Neo-functionalism, which Mario Gandelsonas, in his editorial for *Oppositions 5*, suggests is the appropriate doctrine for the next phase of architecture, is rejected on the grounds that it does not recognize the crucial difference between modernism and humanism.

These comments suggest that Eisenman's defense of his position is reduced to the argument that if we fail to define architecture as an autonomous object, architects will be out of step with the sensibility that dominates the other arts. The criterion thus offered for the validity of post-functionalism is its similarity to the point of view that has been adopted in painting, sculpture, literature, and music. Indeed, Eisenman points specifically to several examples of the modernist esthetic to indicate the ideational modes he would like architecture to follow: the non-objective abstract painting of Malevich and Mondrian; the non-narrative atemporal writing of Joyce and Apollinaire; the atonal and polyphonal compositions of Schoenberg and Webern; the non-narrative films of Richter and Egging.

But isn't the experience of the other arts a flimsy basis on which to validate a conception of architecture? For one, it assumes that architecture is an art in the same sense as the fine arts and literature. But to make this assumption,

we must ignore the history of the arts and of architecture, which demonstrates that pictorial, musical, and literary ideas are only one set among many ideas and forces that have influenced the development of architectural form. Although this is not the place to elaborate a theory of the Modern Movement in architecture, it seems fairly clear, for example, that the differences between the medium of architecture and the medium of painting were largely responsible for the inability of architecture to respond quickly to the introduction of the cubist and purist esthetics in painting. Furthermore, it was the unique character of the architectural phenomenon which required that when Purism was finally incorporated into building, it became a *style* associated with advances in building technology and in program.

Second, to justify the ideology of post-functionalism by what has been happening in the other arts grants too much authority to history. This approach goes along with Eisenman's claim that modernism taps universal truth, while functionalism is an erroneous view generated by past cultures that are now irrelevant. I recoil from the absence of a critical attitude toward present-day society that this stance suggests. Why not rather see modernism as so many sociologists, writers, and cultural historians have seen it from the end of the nineteenth century onward? I don't think it depreciates the value of recent art or literature to recognize that it represents a brilliant, but nevertheless limited, struggle to maintain the vitality of the human spirit and imagination in the midst of a society which is increasingly hostile to man, to craftsmanship, to personal autonomy, and to authenticity.

Third, there is something curiously demeaning to architecture in Eisenman's desire to model it on the other arts. This denies to architecture its special and

unique character and thus diminishes its achievement in the history of culture.

Still, it is easy to appreciate the ambition of architects of Eisenman's caliber to reject the humanist tradition. Using the mask of humanism and social concern, industrial society has made architecture into a commodity. Professional architects, who once gained their authority through an intimate relationship with a knowledgeable patron, are now men in the middle, to use C. Wright Mills' phrase about the design professions. They are ground down by the demands of a technostucture which, as Galbraith once put it, only wants architecture if it can be produced by a team. Architects today are the victims of a double-decker civilization, as Herbert Read said, in which popular architecture is created by developers and engineers, while architects carry the burden of high culture and have little work. The ideals of utopian and socialist architecture, which not too long ago were looked upon as a means of mitigating the negative consequences of the bureaucratization of the building process, are now discredited.

It is not surprising that faced with these challenges to the integrity of their discipline and craft, architects should try to relieve themselves of their traditional responsibility to make objects for man. Nor is it any wonder that they should want to emphasize those qualities of their product which locate them among the artists, especially now that advanced art has performed the astounding feat of gaining wide acceptance in both high and mass culture, and now that modernist ideas have enabled the arts to communicate with the natural and social science disciplines.

In other words, I think I understand the motives which lead Eisenman to formulate the views presented in the editorial. But the emergence of a compelling need for a new paradigm does

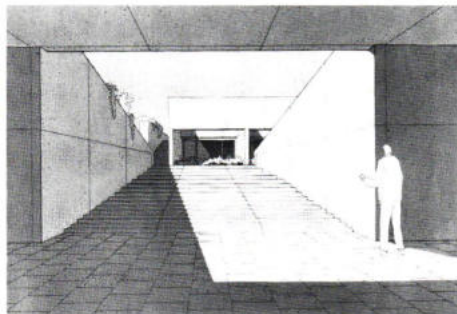

1  
 not make that paradigm therefore true. To establish the truth of a doctrine, the justification of it must proceed beyond history and sociology. The coherence of the theory should be demonstrated. That it works in producing good architecture ought to be established. The ways in which it is compatible with the reality of the built object needs to be spelled out. Its capacity to assimilate the diverse facets of the existential condition of architecture calls out for confirmation. If Eisenman wants us to share his commitment to post-functionalism, he must carry the argument to the next stage. Sincerely yours,  
 Robert Gutman  
 Professor of Sociology, Rutgers University

To the Editors:  
 It distresses me to have to write to the Editors of *Oppositions* about the carelessness of the re-presentation of my work in *Oppositions 5*, particularly when this magazine presents itself as a critical journal of a most precise order.

I hold the "Editors" responsible for the unacceptable re-presentation of my work; they either know better or could not care less.

Item I: The "Diamond" series has been around for a long time, most know (a hint in the title-name alone) that the plans are to be presented in their diamond configuration. To me, this is essential; it has also to do with the conception of the projection system.

Item II: Immodest as it may appear, I consider the "Wall House Series" pivotal works. How can it be that the "Editors" printed the "Bye House" (a wall house) without the wall?

Item III: House #10 plan *should* have been printed horizontally.

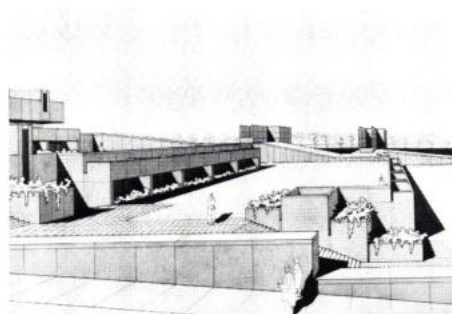

2  
 Item IV: (Non-technical) Tafuri's article is "most curious"; his "literature" I will take care of properly at a future date. Yours truly,  
 John Hejduk  
 A Conservative Conservator, New York

To the Editors:  
 This letter is written specifically at the request of Mr. Kevin Roche who claims he never saw my thesis project until its publication in *Oppositions 4*. Reference was made to the thesis in Robert A. M. Stern's article on Yale as a probable source of influence in the Roche-Dinkeloo design for the Oakland Museum.

Actually Mr. Stern is not the first person to make the observation. Many of my colleagues, students, and architects familiar with my thesis have remarked on the incredible similarity of detail and concept.

The thesis model and drawings were, of course, on exhibit at the Yale University Art Gallery in an architectural exhibit during the entire summer of 1961. Whether Mr. Roche saw the thesis or not, the Oakland Museum is, in my opinion, one of the Roche-Dinkeloo's finest buildings.

It is possible that two minds can have similar ideas. Very truly yours,  
 Der Scutt  
 New York, New York

To the Editors:  
 On page 51 of my article on Yale 1950-1965 in *Oppositions 4*, reference is made to the "probable" influence of Der Scutt's thesis project (figs. 1, 2) on Kevin Roche's design for the Oakland Museum. On 17 May 1976, and subsequent to the publication of this article, I have had a conversation with Mr. Roche who has made it clear to me that he has not at any time seen the

scheme until its publication in *Oppositions*. 97

I would appreciate your publishing this letter in the next issue. Sincerely,  
 Robert A. M. Stern  
 New York, New York

To the Editors:  
 My notes on the forum for Aldo Rossi read: "Neo-Marxist architect in despair throws in the towel." Seeing this, my colleague, Robert Slutzky, quipped, "You mean . . . throws in the trowel." Michael Wurmfeld  
 The Cooper Union, New York

P.S. Too bad such a fine medium as the Forum and *Oppositions 5* were wasted on European esoterica.

To the Editors:  
 The editorial in *Oppositions 6* is a thin imitation of the 1932 Preface by Alfred H. Barr to *The International Style* by Henry-Russell Hitchcock and Philip Johnson:  
 "As was to be expected, several American architects have only recently begun to take up the utility-and-nothing-more theory of design with ascetic zeal. They fail to realize that in spite of his slogan, the house as a machine à habiter, Le Corbusier is even more concerned with style than with convenient planning or plumbing, and that the most luxurious of modern German architects, Mies van der Rohe, has for over a year been the head of the Bauhaus school, having supplanted Hannes Meyer, a fanatical functionalist. 'Post-Functionalism' has even been suggested as a name for the new Style, at once more precise and genetically descriptive than 'International'. (Hitchcock, H. R. and Johnson, P., *The International Style* [Norton Library Edition] pp. 13, 14. Italics added.)  
 Note the clarity and lack of pretension in the original.  
 Michael Wurmfeld  
 New York, New York

1 *Kenneth Frampton addressing the Forum.*

2 *Bernard Tschumi, Stephen Potters, and Andrew MacNair.*

3 *Robert Slutzky and Rafael Moneo.*

4 *Rafael Moneo, John Hejduk, and Mario Gandelsonas.*

5 *William Eitner, Kenneth Frampton, and Giorgio Ciucci.*

6 *Section of the audience.*

7 *Giorgio Ciucci and Peter Eisenman.*

8 *Richard Meier and Piero Sartogo.*

9 *James Rossant and David Morton.*

10 *Suzanne Stephens and Anthony Vidler.*

11 *Kenneth Frampton, Robert Gutman, and John Hejduk.*

12 *Julia Bloomfield and Richard Meier.*

98



1



5

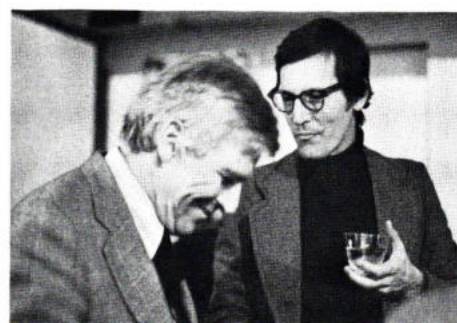

9



2



6



10



3



7



11



4



8



12

## Forum

### Rossi

William Ellis

The Institute's most recent forum attempted to deal with the work of Aldo Rossi. It proved in part that format is not everything. The arrangement was similar to that of the previous and successful forum on The Museum of Modern Art's Beaux Arts exhibition, with set pieces prepared in advance by a panel of practitioners and theoreticians. But the subject was quite different. Rossi's work represents a class of material that American architectural circles seem delighted to discuss as past history, but appear cautious about confronting as current practice.

The quality of the contributions was mixed and, with the exception of James Polshek's piece, most of the panelists seemed poorly prepared. Moreover, the forum seemed carelessly organized, almost as if in the hope that it would all work out by itself. Rossi's work is simply not so familiar in America that it can be addressed in a gathering like this one without at least some kind of preliminary exposition to set a background for the individual pieces.

But beyond this, there seems to be an underlying resistance on the part of the professional and academic public in the United States to deal with architectural phenomena of the strange, personal, and emotionally compacted order that Rossi's images involve. The forum produced the suspicion that there is a strong if unconscious desire on the part of many in the audience not to know anything about Rossi at all. It is as if he were too exotic an item; perhaps a species from some architectural future into which there is no reason to intrude, and which might create an excessive mess should the intrusion take place. Something of this sort suggested itself when, during the discussion, the "ironic" content of Rossi's work was proposed. The exchanges following on this subject were almost incoherent, but clearly controversial. It may be that an "architecture of irony" represents ideas that many Americans cannot understand or will not accept. We tend to doubt the legitimacy of at-

*William Ellis is an Assistant Professor of Architecture at City College of New York, an Assistant Professor (Adjunct) at The Cooper Union, New York, and a Fellow of The Institute for Architecture and Urban Studies.*

titudes or qualities like irony as basic architectural material, notwithstanding the fact that often we can deduce their existence as personal attributes of architects, or detect manifestations of them as secondary characteristics of an architecture. We tend to discount the possible instrumentality of a notion like irony as an architectural or social quality, or as a function of the development of the cultural process. "Irony" may, in fact, not be instrumental at all, but assessments of these kinds one way or the other seem necessary in order to clarify what, if anything, is so compelling about the work of Rossi.

For the interest in his images probably lies in their complete rejection of the assumptions of modern architecture and their absolute inversion of its objectives: images that appear as tragic or naive fragments; quotations from clearly historicist forms; images exhibiting introspection, turning inward from a social milieu toward whatever it is in architecture that concerns only itself; images that presuppose a monumental isolation from the context of the physical city.

Commentary on all this was limited to only a small number of projects—mostly the gloomy ones—and, with the exception of Polshek, was mainly a rehearsal of the existing critical menu on Rossi. As such, it was opaque to those not exposed to it before; for those more familiar with the subject, it seemed to re-describe too much and explain too little. This is unfortunate, because the contradictions between Rossi's work and mainstream theory and practice force us to make judgments that should be more than casual or gratuitous. Is Rossi's work merely the hyper-mannerism of a connoisseur for connoisseurs? Or might it not point to different but equally large contradictions inherent in modern architecture? Does it represent a desperate escapism, or is it, in fact, a new medium for an engaged architectural, social, and cultural conscience? What might be the role of *irony* or the role of personal rather than

13 *Lauretta Vinciarelli and Susana Torre.*

14 *James Polshek.*

15 *Philip Johnson, Peter Eisenman, and Michael Graves.*

16 *The Forum.*



13



14



15



16

100 generalized statements in architecture and urbanism today?

To an American audience, an architecture of irony—if that indeed is what it is—must be explained, argued, assessed; not merely suggested to exist. Such a discourse might reveal a number of other footholds, which would help to bring the phenomenon into clearer critical focus. For instance, it seems that an architecture manifesting irony might be open to other non-modern qualities; and, in fact, Rossi's images suggest a number of these. Among them is the idea of a greater anthropomorphic content than might be apparent at first, despite all the "emptiness" and blank apertures—and not only because he resurrects forms that pre-date the Machine Age. More to the point, he seems to be trying to resuscitate a quality that modern architecture had dispensed with in its vigorous youth—he is trying to retrieve the possibility of *mood* in architecture. It is but a short step from this physiognomic condition to the emergence of other anthropomorphic qualities. Such a case cannot be made complete here, but if propositions such as these are valid to any extent at all, they would show him to be the most revisionist of all revisionists to date, and at the same time one of a distinctly different character and direction: one who suggests the possibility again of an architecture of *visage* as well as of *physique*.

The spirit of modern architecture, as the final flowering of the Enlightenment, could be said to be nostalgic for the future. Up to this time at least, Rossi's images imply that he is immersed, sometimes bitterly, in a contradictory present. In this he is an iconoclast, embarked on a program of the destruction of modern architecture; and in this he is not unique. But the tragic, romantic quality of most of his work is more suggestive of euthanasia than simple homicide. It invokes the engaged, pathetic condition of a conspirator in a mercy killing: sad, but for the best. Above all, it is this capacity of his images to suggest high seriousness of purpose that tends to call up

responses of this kind, and that separates him from other iconoclasts who come easily to mind, such as Steinberg or even Oldenburg. As such, his work deserves to be compared with other revisionist positions. It should be subjected to a critical approach that would balance against Manfredo Tafuri's Marxist judgment in *Oppositions 3*, as well as against the classic line of modern architecture.

Only by addressing Rossi's work along some lines of thought that have connections for us outside his images can we confront the contradictions they suggest; for it is principally within the space of these contradictions that the value or else the vacuity of his work may be established for those of us who are in no position to merely accept it as it stands. Early modern architecture was highly theoretic and millenarian. It has led, not without some awareness of the problems within that process, to where we are now. It seems at least possible that prospects leading away from our present position will involve the examination of energies literally foreign to our more familiar assumptions and inertias. By contrast with the vague apathy toward such ideas shown in the United States, one is led to suspect that material such as Rossi's work is virtually the stuff of popular digestion in the European—and especially the Italian—architectural subculture, from *capo to studente*; and the comparison is unsettling. For if Rossi represents a phenomenon that at present can be only European, this hardly implies that it will always be so.

This is not to suggest that Rossi's work is simply to be accepted without reservations. This reviewer has a number of them concerning apparent discrepancies between Rossi's images and his pronouncements. The attitudes reflected in this review spring not from any reflex support of the work of Rossi, but rather from an interest in what modern architecture up to this point has so far neglected to address. This same willingness to look at what might be exotica in terms of the or-

thodoxy of the Modern Movement was certainly present in the contributions of the panelists at the Rossi forum, but it was carelessly and confusingly communicated. The suspicion lingers, however, that had it been more clearly presented, it might still have been poorly received.

Figure Credits  
Photographs by Dorothy Alexander

**Gaudí:**  
His Life, His Theories,  
His Work  
by César Martinell  
translated from the Spanish  
by Judith Rohrer  
edited by George R. Collins

This magnificent volume is a fitting monument to the Catalan architect, Antonio Gaudí. It is the only book on Gaudí that is fully commensurate with the dimensions of his greatness, and in its completeness and detail it simply supplants all previous accounts. All of Gaudí's projects are illustrated in 555 photographs of buildings, sculptures, furnishings, and plans, including 60 full-color plates—a significant feature, since color was an integral part of Gaudí's architectural realizations. Many of these illustrations depict objects unearthed by the author in recent years and are made available here for the first time.

**\$50.00**

**Architecture and Utopia:**  
Design and Capitalist  
Development  
by Manfredo Tafuri

This essay, written from a neo-Marxist point of view by a prominent Italian architectural historian, is meant to lead the reader beyond the facade of architectural form into a broader understanding of the relation of architecture to society and architects to the workforce and the marketplace.

Tafuri argues that architects in the capitalist milieu should not aspire to be designers of stable forms but rather planners of *processes* that are open-ended in time. Their work should serve the economic needs of the cities, to be replaced when changing conditions demand new accommodations.

**\$9.95**

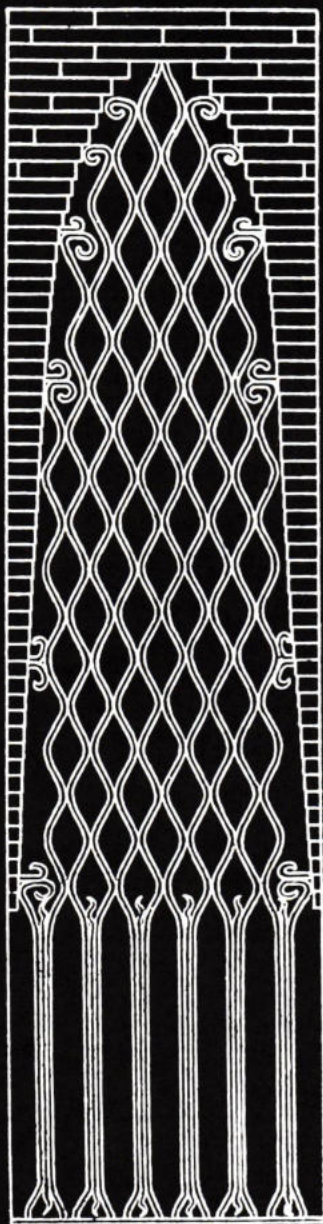

## Ideals sleep Ideals sleep Ideals

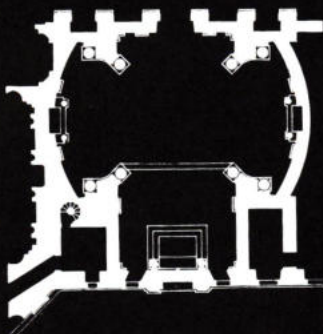

**The Mathematics of the Ideal  
Villa and Other Essays**  
by Colin Rowe

Charles Jencks wrote in *Modern Movements in Architecture* (1973): "... when Colin Rowe published his article 'The Mathematics of the Ideal Villa' in 1947, those who had been following the emergent Neo-Platonism, that is, those close to the Warburg [Institute], were not surprised. Here was New Palladianism fully born right from the top of Corbusier's head."

In addition to this influential essay, the book contains eight others on architecture, classical and modern.

**\$15.95**

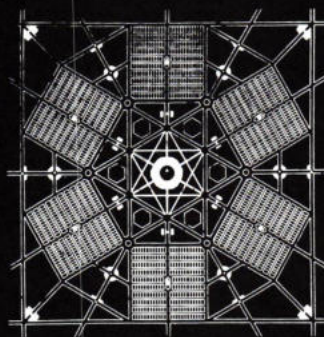

**Seven American Utopias:**  
The Architecture of Communitarian  
Socialism, 1790-1975  
by Dolores Hayden

The interplay between ideology and architecture, the social design and the physical design of American utopian communities, is the basis of this remarkable book.

At its heart are studies of seven communitarian groups, collectively stretching over nearly two centuries and the full breadth of the American continent—the Shakers of Hancock, Massachusetts; the Mormons of Nauvoo, Illinois; the Fourierists of Phalanx, New Jersey; the Perfectionists of Oneida, New York; the Inspirationists of Amana, Iowa; the Union Colonists of Greeley, Colorado; and the Cooperative Colonists of Llano del Rio, California. Hayden examines each of these groups to see how they coped with three dilemmas that all socialist societies face: conflicts between authoritarian and participatory processes, between communal and private territory, and between unique and replicable community plans.

**\$16.95**

**The MIT Press**  
Massachusetts Institute of  
Technology  
Cambridge, Massachusetts  
02142

# other books from The MIT Press

- Principles of Architectural History**  
by Paul Frankl  
translated by James F. O'Gorman  
1968—7 X 10—240 pp.—illus.—\$20.00
- Intentions in Architecture**  
by Christian Norberg-Schulz  
1966—8 3/8—8 3/4—300 pp.—illus.—\$16.50  
Paper—MIT-100—\$6.95
- Experiencing Architecture**  
second edition  
by Steen Eiler Rasmussen  
1962—6 X 9—245 pp.—illus.—\$10.00  
Paper—MIT-2—\$4.95
- File under Architecture**  
by Herbert Muschamp  
1974—6 X 9—120 pp.—\$10.95
- The Geometry of Environment**  
An Introduction to Spatial Organization in Design  
by Lionel March and Philip Steadman  
Paper—1974—6 1/2 X 9 1/2—360 pp.—\$12.50
- The Architecture Machine**  
by Nicholas Negroponte  
1970—7 3/8 X 7 3/8—164 pp.—illus.—\$7.95  
Paper—MIT-216—\$3.95
- Soft Architecture Machines**  
by Nicholas Negroponte  
1975—7 3/8 X 7 3/8—140 pp.—illus.—\$14.95
- Toward a Scientific Architecture**  
by Yona Friedman  
1975—5 3/8 X 8—208 pp.—\$12.50
- Energy and Form**  
An Ecological Approach to Urban Growth  
by Ralph L. Knowles  
1974—10 X 8 1/2—176 pp.—illus.—\$27.50
- Developments in Structural Form**  
by Rowland J. Mainstone  
1974—8 1/4 X 11 3/4—425 pp.—illus.—\$25.00
- American Architecture Since 1780**  
A Guide to the Styles  
by Marcus Whiffen  
1969—5 5/8 X 7 1/2—320 pp.—illus.—\$15.00
- The Classical Language of Architecture**  
by John Summerson  
1966—9 1/4 X 7 1/2—80 pp.—illus.—\$9.95  
Paper—MIT-61—\$3.45
- Architectural Space in Ancient Greece**  
by Constantinos A. Doxiadis  
1972—6 7/8 X 11—256 pp.—illus.—\$9.95
- Orthogonal Town Planning in Antiquity**  
by Ferdinando Castagnoli  
1971—7 X 10—144 pp.—illus.—\$7.95
- Caves of God**  
The Monastic Environment of Byzantine Cappadocia  
by Spiro Kostof  
1972—7 X 10—296 pp.—illus.—\$20.00
- The Architecture of H. H. Richardson and His Times**  
second edition  
by Henry-Russell Hitchcock  
Paper—1966—5 3/8 X 8—343 pp.—illus.—MIT-43—\$5.95
- History of Modern Architecture**  
by Leonardo Benevolo  
Vol. 1: 1972—7 1/2 X 10—374 pp.—\$22.50  
Vol. 2: 1972—7 1/2 X 10—470 pp.—\$22.50
- Programs and Manifestoes on 20th-Century Architecture**  
edited by Ulrich Conrads  
1971—5 1/4 X 8—190 pp.—\$12.50  
Paper—MIT-286—\$4.95
- The Architecture of Frank Lloyd Wright**  
A Complete Catalog  
by William Allin Storrer  
foreword by Henry-Russell Hitchcock  
1974—5 X 8—289 pp.—illus.—\$12.95
- The New Architecture and The Bauhaus**  
by Walter Gropius  
Paper—1965—5 X 8—112 pp.—illus.—MIT-21—\$3.45
- Ludwig Mies van der Rohe**  
Drawings in the Collection of the Museum of Modern Art  
edited by Ludwig Glaeser  
1974—24 1/2 X 18—70 pp.—illus.—\$20.00
- The Modulor**  
by Le Corbusier  
Paper—1968—7 3/8 X 7 3/8—244 pp.—illus.—MIT-96—\$3.95
- Modulor 2**  
by Le Corbusier  
Paper—1968—7 3/8 X 7 3/8—336 pp.—illus.—MIT-97—\$3.95
- Lived-In Architecture**  
Le Corbusier's Pessac Revisited  
by Philippe Boudon  
translated by Gerald Onn  
1972—5 3/8 X 8—152 pp.—illus.—\$5.95
- Team 10 Primer**  
edited by Alison Smithson  
1968—8 X 9 3/4—112 pp.—illus.—Paper—MIT-268—\$4.95
- Ordinariness and Light**  
by Alison and Peter Smithson  
1970—7 X 10—195 pp.—illus.—\$12.50
- Without Rhetoric**  
An Architectural Aesthetic 1955-1972  
by Alison and Peter Smithson  
1974—7 X 8 1/4—104 pp.—illus.—\$6.95
- The Notebooks and Drawings of Louis I. Kahn**  
second edition  
edited by Richard Saul Wurman and Eugene Feldman  
1974—11 X 15—92 pp.—illus.—\$17.50
- Beyond Habitat**  
by Moshe Safdie  
1970—6 1/2 X 9 1/4—244 pp.—illus.—\$12.50  
Paper—MIT-217—\$3.45
- For Everyone a Garden**  
by Moshe Safdie  
edited by Judith Wolin  
1974—9 X 9—256 pp.—illus.—\$14.95
- The Sketchbooks of Paolo Soleri**  
by Paolo Soleri  
1971—11 X 8 1/2—420 pp.—illus.—\$27.50  
Paper—\$12.95
- Arcology**  
The City in the Image of Man  
by Paolo Soleri  
1970—14 X 9 1/2—256 pp.—extensively illustrated with the author's drawings—\$25.00

## Individual Sponsors

Michael S. Adams  
Diana Agrest  
Emilio Ambasz  
Stanford Anderson  
Lily Auchincloss  
Edmund N. Bacon  
George Baird  
Richard A. Baiter  
Edward Larrabee Barnes  
Jonathan Barnett  
Armand Bartos  
Lawrence Booth  
Robert F. Borg  
Samuel M. Brody  
Lance Jay Brown  
Robinson O. Brown  
John Burgee  
Duarte Cabral de Mello  
Peter Carl  
Alan Chimacoff  
Henry N. Cobb  
Elaine Lustig Cohen  
Stuart Cohen  
William J. Conklin  
Lewis Davis  
Arthur Drexler  
George Dudley  
Anthony Eardley  
Peter Eisenman  
William Ellis  
David Elwell  
John Entenza  
Michael M. Fieldman  
Earl Flansburgh  
Harrison Fraker, Jr.  
Kenneth Frampton  
Suzanne Frank  
Ulrich Franzen  
James Ingo Freed  
Jonathan Friedman  
Mario Gandelsonas  
Robert Geddes  
Frank O. Gehry  
Romaldo Giurgola

Ludwig Glaeser  
Robert Golder  
Michael Graves  
Allan Greenberg  
Antoine Grumbach  
Jordan Gruzen  
Robert Gutman  
Charles Gwathmey  
John Haggmann  
Frances Halsband  
John Hejduk  
Richard Henderson  
Peter Hoppner  
Franklin Israel  
Barbara Jakobson  
Philip Johnson  
Robert Jones  
Gerhard Kallmann  
J. Michael Kirkland  
R. M. Kliment  
Fred Koetter  
Alexander Kouzmanoff  
Etel Thea Kramer  
Theodore Liebman  
Donlyn Lyndon  
Rodolfo Machado  
Andrew P. MacNair  
Michael McCarthy  
N. Michael McKinnell  
Richard Meier  
Carl Meinhardt  
Henry Millon  
Charles Moore  
Barton Myers  
Oscar Newman  
Peter Papademetriou  
Spencer Parsons  
Giovanni Pasanella  
Anthony Pergola  
G. Daniel Perry  
Steven K. Peterson  
James Polshek  
Stephen Potters  
David Reiser

Jacquelin Robertson  
James Rossant  
Colin Rowe  
Paul Rudolph  
Peter Samton  
Piero Sartogo  
Thomas Schumacher  
Jon Michael Schwarting  
Denise Scott Brown  
Sean West Sculley  
Vincent Scully  
Werner Seligmann  
Elna Shulof  
Robert Siegel  
Jorge Silveti  
Robert Slutzky  
Henry Smith-Miller  
Jerzy Soltan  
Bernard P. Spring  
Frank Stanton  
Robert A. M. Stern  
James Stirling  
Peter Szilagyi  
Frederieke S. Taylor  
Stanley Tigerman  
Robert H. Timme  
Susana Torre  
O. Matthias Ungers  
Robert Venturi  
Anthony Vidler  
Massimo Vignelli  
Lauretta Vinciarelli  
Thomas R. Vreeland, Jr.  
Ralph Warburton  
Benjamin H. Weese  
Richard Weinstein  
T. Reynolds Williams  
Tod Williams  
Peter Wolf  
Timothy Wood  
Stuart Wrede  
Michael Wurmfeld  
Bernard Zimmerman